**User's
Manual**

Model UT750
Digital Indicating Controller
User's Manual for Cascade Control with
Two Universal Inputs



IM 05D01B02-53E

Blank Page

Introduction

Thank you for purchasing the UT750 digital indicating controller.

■ How to Use the Manuals

Purpose	Title	Description
Setup	1. Installation	Describes the tasks (installation, wiring, and others) required to make the controller ready for operations.
Basic operation	2. Initial Settings	Describes examples of setting PV input types, control output types, and alarm types. Making settings described herein allows you to carry out basic control.
Operating procedures and troubleshooting	3. Operations 4.1 Troubleshooting	Describes key operation sequences. For operation control through external contact inputs, see "1.5 Terminal Wiring Diagrams."
Brief operation	5.1 Parameter Map	Contains the parameter map used as a guideline for setting parameters.
Function description and setpoint recording	5.2 Lists of Parameters	Briefly describes the functions of parameters. In addition, each parameter table has a User Setting column, where you can record your setpoints when setting them in the controller.

■ Controllers Applicable to Cascade Control with Two Universal Inputs

The specification codes of the UT750 applicable to cascade control with two universal inputs are given in the table below.

UT750-50	UT750-51
----------	----------

■ Regarding This User's Manual

- (1) This manual should be provided to the end user. Keep an extra copy or copies of the manual in a safe place.
- (2) Read this manual carefully to gain a thorough understanding of how to operate this product before starting operation.
- (3) This manual describes the functions of this product. Yokogawa Electric Corporation (hereinafter simply referred to as Yokogawa) does not guarantee the application of these functions for any particular purpose.
- (4) Under absolutely no circumstances may the contents of this manual, in part or in whole, be transcribed or copied without permission.
- (5) The contents of this manual are subject to change without prior notice.
- (6) Every effort has been made to ensure that the details of this manual are accurate. However, should any errors be found or important information be omitted, please contact your nearest Yokogawa representative or our sales office.

■ Safety Precautions

The following symbol is indicated on the controller to ensure safe use.



This symbol on the controller indicates that the operator must refer to an explanation in the user's manual in order to avoid the risk of injury or death of personnel or damage to the instrument. The manual describes how the operator should exercise special care to avoid electric shock or other dangers that may result in injury or loss of life.

The following symbols are used in the hardcopy user's manuals and in the user's manual supplied on the CD-ROM.



Indicates that operating the hardware or software in a particular manner may damage it or result in a system failure.



Draws attention to information that is essential for understanding the operation and/or features of the controller.

■ Force Majeure

- (1) Yokogawa assumes no liability to any party for any loss or damage, direct or indirect, caused by the use or any unpredictable defect of the product.
- (2) No portion of the software supplied by Yokogawa may be transferred, exchanged, leased or sublet for use by any third party without the prior permission of Yokogawa.
- (3) Be sure to use the spare parts approved by Yokogawa when replacing parts or consumables.
- (4) Use this software with one specified computer only. You must purchase another copy of the software for use on each additional computer.
- (5) Copying this software for purposes other than backup is strictly prohibited.
- (6) Store the floppy disk(s) (original medium or media) containing this software in a secure place.

■ Regarding Protection, Safety, and Prohibition Against Unauthorized Modification

- (1) In order to protect the product and the system controlled by it against damage and ensure its safe use, make certain that all of the instructions and precautions relating to safety contained in this document are strictly adhered to. Yokogawa does not guarantee safety if products are not handled according to these instructions.
- (2) Modification of the product is strictly prohibited.
- (3) Reverse engineering such as the disassembly or decompilation of software is strictly prohibited.

Blank Page

Model UT750

Digital Indicating Controllers User’s Manual for Cascade Control with Two Universal Inputs

IM 05D01B02-53E 2nd Edition

CONTENTS

- Introduction i
- 1. Installation 1-1
 - 1.1 Model and Suffix Codes 1-1
 - 1.2 How to Install 1-2
 - 1.3 How to Connect Wires 1-5
 - 1.4 Hardware Specifications 1-7
 - 1.5 Terminal Wiring Diagrams 1-13
- 2. Initial Settings 2-1
 - 2.1 Names and Functions of Front Panel Parts 2-2
 - 2.2 Setting UT mode (Setting First at Power-on) 2-3
 - 2.3 Changing UT mode 2-4
 - 2.4 Setting Primary and Secondary PV Input Types 2-6
 - 2.5 Setting Control Output Type 2-10
 - 2.6 Initializing Parameters 2-12
 - 2.7 Changing Alarm Type of Primary-loop 2-13
 - 2.8 Description of Multiple Setpoints and PID 2-16
- 3. Operations 3-1
 - 3.1 Monitoring-purpose Operating Displays Available during Operation 3-1
 - 3.2 Setting Target Setpoint (SP) of Primary-loop 3-6
 - 3.3 Setting Target Setpoint (SP) of Secondary-loop 3-8
 - 3.4 Performing/Canceling Auto-tuning of Secondary-loop 3-10
 - 3.5 Performing/Canceling Auto-tuning of Primary-loop 3-12
 - 3.6 Setting PID of Secondary-loop Manually 3-14
 - 3.7 Setting PID of Primary-loop Manually 3-16
 - 3.8 Setting Alarm Setpoints of Primary-loop 3-17
 - 3.9 Selecting Target Setpoint Numbers (SPNO) 3-19
 - 3.10 Switching between Run and Stop 3-20
 - 3.11 Switching between Cascade (CAS), AUTO and MAN 3-21
 - 3.12 Manipulating Control Output during Manual Operation 3-23

4.	Troubleshooting and Maintenance	4-1
4.1	Troubleshooting	4-1
4.2	Maintenance	4-6
4.2.1	Cleaning	4-6
4.2.2	Replacing Brackets	4-6
4.2.3	Attaching Terminal Cover	4-7
4.2.4	Replacing Parts with a Limited Service Life	4-8
4.2.5	Replacing Control Output Relays	4-9
5.	Parameters	5-1
5.1	Parameter Map	5-1
5.2	Lists of Parameters	5-6
6.	Function Block Diagram and Descriptions	6-1
	Revision Information	i

1. Installation

This chapter describes installation, wiring, and other tasks required to make the controller ready for operation.

1.1 Model and Suffix Codes

Before using the controller, check that the model and suffix codes match your order.

Model	Suffix Code	Description
UT750		Digital indicating controller (provided with Custom Computing Function*)
Type	-0	Single-loop type
	-1	Position proportional type
	-5	Dual-loop type
Optional functions	0	None
	1	With communication, auxiliary analog (remote) input

Check that the following items are provided:

- Digital indicating controller (of ordered model) 1
- Brackets (mounting hardware) 1 pair
- Unit label 1
- User's Manuals for Single-loop Control 5 (A2 size)
- User's Manual (Reference) (CD-ROM version) 1

* Using an optional custom computation building tool (Model LL200-E10) that runs on a personal computer, you can build a variety of computations (e.g., four arithmetic operations, logical operations, ten-segment linearizer computations, temperature correction factor computations, and pressure correction factor computations) to be applied to the controller's I/O signals.

1.2 How to Install

NOTE

To install the controller, select a location where:

1. no one may accidentally touch the terminals,
2. mechanical vibrations are minimal,
3. corrosive gas is minimal,
4. temperature can be maintained at about 23°C and the fluctuation is minimal,
5. no direct radiant heat is present,
6. no magnetic disturbances are caused,
7. no wind blows against the terminal board (reference junction compensation element),
8. no water is splashed,
9. no flammable materials are around,

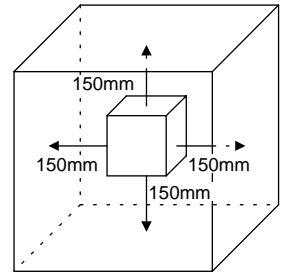

Never place the controller directly on flammable items or equipment.

If the controller has to be installed close to flammable items or equipment, be sure to provide shielding panels all around the controller, at least 150 mm away from every side; the panels should be made of either 1.43 mm-thick metal-plated steel plates or 1.6 mm-thick uncoated steel plates.

● Installation Position

Install the controller at an angle within 30° from horizontal with the front panel facing upward. Do not install it facing downward. The position of right and left sides should be horizontal.

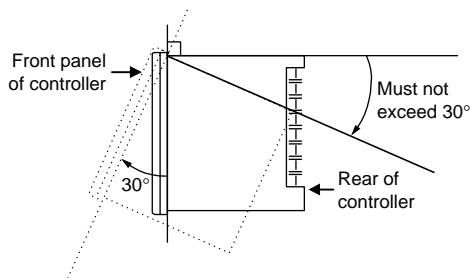

External Dimensions and Panel Cutout Dimensions

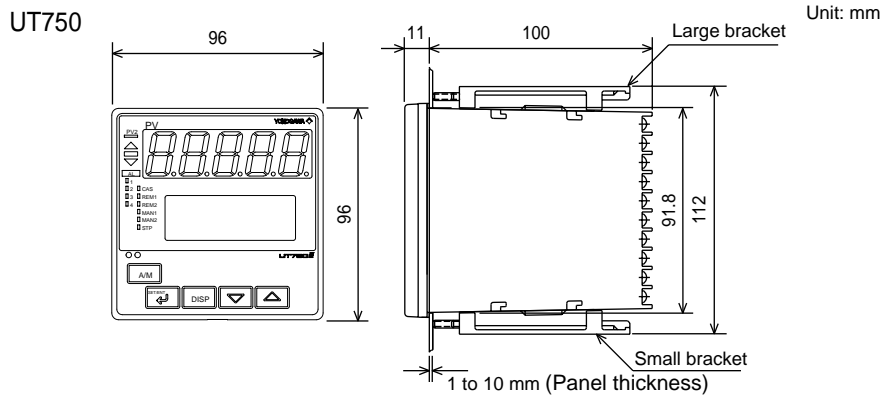

General installation

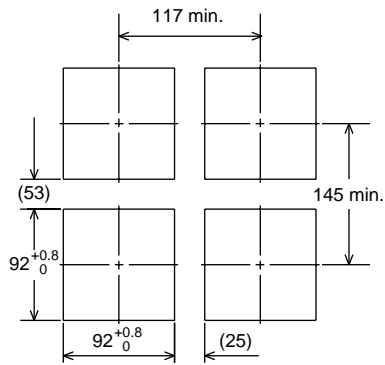

Side-by-side close installation

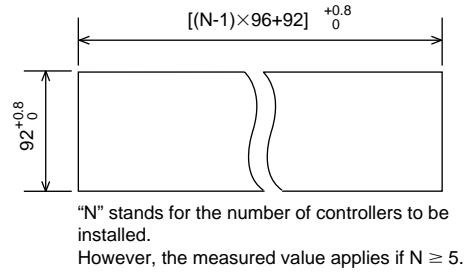

■ How to Install



CAUTION

Turn off the power to the controller before installing it on the panel because there is a possibility of electric shock.

After opening the mounting hole on the panel, follow the procedures below to install the controller:

1. Insert the controller into the opening from the front of the panel so that the terminal board on the rear is at the far side.
2. Set the brackets in place on the top and bottom of the controller as shown in the figure below, then tighten the screws of the brackets. Take care not to overtighten them.

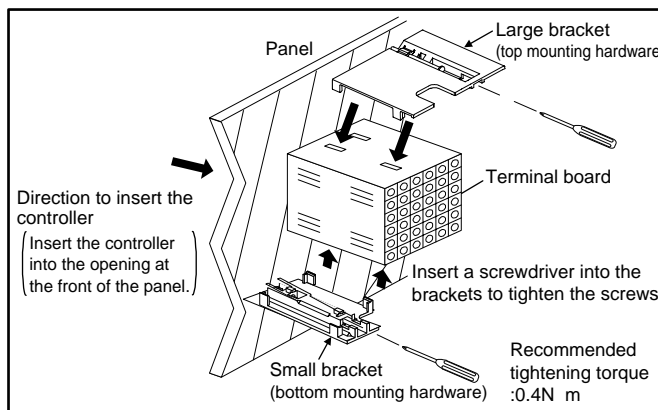

1.3 How to Connect Wires



- 1) Before carrying out wiring, turn off the power to the controller and check that the cables to be connected are not alive with a tester or the like because there is a possibility of electric shock.
- 2) For the protection and safe use of the controller, be sure to place a circuit breaker (conforms with IEC60947, 5A, 100V or 220V AC) near the controller where the breaker can easily be operated. In addition, be sure to indicated that it is the instrument to cut the power supply of the controller.
- 3) Wiring must be carried out by personnel who have basic electrical knowledge and practical experience.



- 1) Provide power from a single-phase instrument power supply. If there is a lot of noise in the power line, insert an insulating transformer into the primary side of the line and use a line filter (recommended part: ZAC2205-00U from TDK) on the secondary side. As a countermeasures against noise, do not place the primary and secondary power cables close to each other.
- 2) For thermocouple input, use shielded compensating lead wires for wiring. For RTD input, use shielded wires that have low conductor resistance and cause no significant differences in resistance between the three wires. The cables to be used for wiring, terminal specifications, and recommended parts are as shown below.
- 3) Control output relays may be replaced. However, because they have a life of 100,000 times that of the resistance load, use auxiliary relays to turn on/off a load.
- 4) The use of inductance (L) loads such as auxiliary relays, motors and solenoid valves causes malfunction or relay failure; always insert a CR filter for use with alternating current or a diode for use with direct current, as a spark-removal surge suppression circuit, into the line in parallel with the load.
- 5) When there is a possibility of being struck by external lightning surge, use the arrester to protect the instrument.

■ For DC Relay Wiring

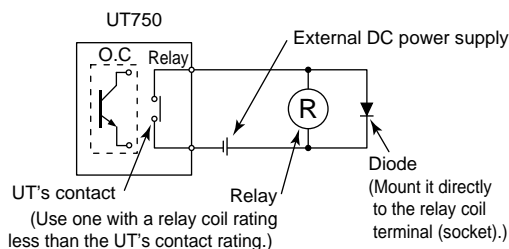

■ For AC Relay Wiring

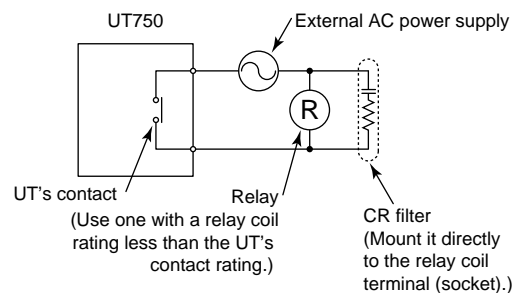

● Cable Specifications and Recommended Cables

Purpose	Name and Manufacturer
Power supply, grounding, relay contact outputs	600 V PVC insulated wires, JIS C 3307, 0.9 to 2.0 mm ²
Thermocouple	Shielded compensating lead wires, JIS C 1610, □X-□-□-□ (See Yokogawa Electric's GS 6B1U1-E.)
RTD	Shielded wires (three conductors), UL2482 (Hitachi Cable)
Other signals	Shielded wires

● Recommended Terminal Lugs

Applicable wire size	Tightening torque
0.3 to 1.65 mm ²	0.8 N·m or less

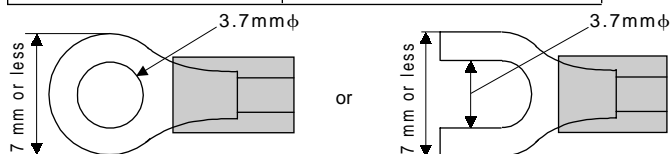

● Terminal Covers

Target Model	Part Number	Sales Unit
For UT750	T9115YD	1

1.4 Hardware Specifications

PV Input Signals (Primary and Secondary PV Input)

- Number of inputs: 2 (primary: terminals ⑪-⑫-⑬, secondary: terminals ④①-④②-④③)
- Input type: Universal input system. The input type can be selected with the software.
- Sampling period: 50, 100, 200 and 500 ms (The sampling period can be selected with the software.)
Initial value; 200 ms
- Burnout detection: Functions at TC, RTD, standard signal (0.4 to 2 V or 1 to 5 V)
Upscale, downscale, and off can be specified.
For standard signal, burnout is determined to have occurred if it is 0.1 V or less.
- Input bias current: 0.05 μ A (for TC or RTD b-terminal)
- Measurement current (RTD): About 0.13 mA
- Input resistance: 1 M Ω or more for thermocouple or mV input
About 1 M Ω for DC voltage input
Secondary PV input of 0.00 to 1.25 V range is about 8 M Ω .
- Allowable signal source resistance: 250 Ω or less for thermocouple or mV input
Effects of signal source resistance: 0.1 μ V/ Ω or less
2 k Ω or less for DC voltage input
Effects of signal source resistance: About 0.01%/100 Ω
- Allowable wiring resistance: for RTD input
Maximum 150 Ω /wire: Conductor resistance between three wires should be equal
However, 10 Ω /wire for a maximum range of -150.0 to 150.0 $^{\circ}$ C.
Wire resistance effect: \pm 0.1 $^{\circ}$ C/10 Ω
- Allowable input voltage: \pm 10 V DC for thermocouple, mV, or RTD input
 \pm 20 V DC for DC voltage input
- Noise rejection ratio: 40 dB (50/60 Hz) or more in normal mode
120 dB (50/60 Hz) or more in common mode
- Reference junction compensation error: \pm 1.0 $^{\circ}$ C (15 to 35 $^{\circ}$ C)
 \pm 1.5 $^{\circ}$ C (0 to 15 $^{\circ}$ C, 35 to 50 $^{\circ}$ C)
- Applicable standards: JIS, IEC, DIN (ITS-90) for thermocouples and RTD

Auxiliary Analog Input Signals (Remote Input)

Available only for controllers with auxiliary analog input terminals.

- Number of inputs: 1 (terminals ⑳-㉑)
- Input type: Settable in a range of 0-2, 0-10, 0.4-2.0, or 1-5 V DC
- Sampling period: 100, 200 and 500 ms
The sampling period of an auxiliary analog input signal is associated with the PV input's sampling period. If the PV input's sampling period is 50 ms, however, the sampling period of an auxiliary analog input signal lengthens to 100 ms.
- Input resistance: About 1 M Ω
- Input accuracy: \pm 0.3% \pm 1 digit of input span for 0 to 2 V DC
 \pm 0.2% \pm 1 digit of input span for 0 to 10 V DC
 \pm 0.375% \pm 1 digit of input span for 0.4 to 2.0 V DC
 \pm 0.3% \pm 1 digit of input span for 1 to 5 V DC
Under standard operating conditions (23 \pm 2 $^{\circ}$ C, 55 \pm 10% RH, power frequency of 50/60 Hz)

Loop Power Supply

Power is supplied to a two-wire transmitter.
(15 V DC: terminals ⑭-⑮)

A resistor (10 to 250 Ω) connected between the controller and transmitter converts a current signal into a voltage signal, which is then read via the PV input terminal.
Supply voltage: 14.5 to 18.0 V DC, max. 21 mA (provided with a protection circuit against a field short-circuit)

Retransmission Output

Either PV, target setpoint, or control output is output.

Either the retransmission output or the loop power supply can be used with terminals ⑭-⑮.

- Number of outputs: 1 or 2 (terminals ⑭-⑮, terminals ⑯-⑰)
- Output signal: 4-20, 0-20, 20-4, or 20-0 mA DC (where, outputting signal levels of less than 0 mA is not feasible)
- Load resistance: 600 Ω or less
- Output accuracy: ±0.1% of span (±5% of span for 1 mA or less.) under standard operating conditions (23±2°C, 55±10% RH, power frequency of 50/60 Hz)

Control Output

Universal output system, The output type can be selected with the software.

- Current output
(Dual-loop type: terminals ⑯-⑰; heating-side output: terminals ⑯-⑰, cooling-side output: terminals ⑭-⑮)

Number of outputs	1 or 2 (two for heating/cooling control), switched between a voltage pulse output and current output.
Output signal	4-20, 0-20, 20-4, or 20-0 mA DC
Load resistance	600 Ω or less
Output accuracy	±0.1% of span (±5% of span for 1 mA or less) Under standard operating conditions (23±2°C, 55±10% RH, power frequency of 50/60 Hz)

- Voltage pulse output
(Dual-loop type: terminals ⑯-⑰; heating-side output: terminals ⑯-⑰, cooling-side output: Not selected)

Number of outputs	1 switched between a voltage pulse output and current output.
Output signal	On-voltage = 12 V or more (load resistance: 600 Ω or more) Off-voltage = 0.1 V DC or less
Resolution	10 ms or 0.1% of output, whichever is larger

- Relay contact output
(Dual-loop type: terminals ①-②-③, heating-side output: terminals ①-②-③, cooling-side output: terminals ④-⑦)

Number of outputs	1 or 2 (two for heating/cooling control)
Output signal	Three terminals (NC, NO, and common) / Two terminals
Contact rating	Terminals 1-2-3 : 250 V AC or 30 V DC, 3 A (resistance load) Terminal 4-7 : 240 V AC or 30 V DC, 1A (resistance load)
Resolution	10 ms or 0.1% of output, whichever is larger

Contact Inputs

- Purpose: Target setpoint selection, remote/local mode switching, and run/stop switching
- Number of inputs: 7
- Input type: Non-voltage contact or transistor open collector input
- Input contact rating: 12 V DC, 10 mA or more
- On/off determination: For non-voltage contact input, contact resistance of 1 k Ω or less is determined as "on" and contact resistance of 20 k Ω or more as "off."
For transistor open collector input, input voltage of 2 V or less is determined as "on" and leakage current must not exceed 100 μ A when "off."
- Minimum status detection hold time: PV input's sampling period \times 3

Contact Outputs

- Purpose: Alarm output, FAIL output, and others
- Number of outputs: 7 (relay: 3, transistor: 4)
- Relay contact rating: 240 V AC, 1 A, or 30 V DC, 1 A (COM terminal is common)
- Transistor contact rating: 24 V DC, 50 mA (COM terminal is common)

Display Specifications

- PV display: 5-digit, 7-segment, red LEDs, character height of 20 mm for UT750
- Setpoint display: 32 \times 128 dot LCD display with back-light
- Status indicating lamps: LEDs

Safety and EMC Standards

- Safety: Compliant with IEC/EN61010-1: 2001, approved by CSA1010, approved by UL508.

Installation category : CAT. II (IEC/EN61010, CSA1010) Pollution degree : 2 (IEC/EN61010, CSA1010)

Measurement category : I (CAT. I : IEC/EN61010)

Rated measurement input voltage : 10V DC max.(across terminals), 300V AC max.(across ground)

Rated transient overvoltage : 1500V (Note)

Note : It is a value on the safety standard which is assumed by IEC/EN61010-1 in measurement category I, and is not the value which guarantees an apparatus performance.



CAUTION

This equipment has Measurement category I, therefore do not use the equipment for measurements within measurement categories II, III and IV.

Measurement category		Description	Remarks
I	CAT. I	For measurements performed on circuits not directly connected to MAINS.	
II	CAT. II	For measurements performed on circuits directly connected to the low voltage installation.	Appliances, portable equipments, etc.
III	CAT. III	For measurements performed in the building installation.	Distribution board, circuit breaker, etc.
IV	CAT. IV	For measurements performed at the source of the low-voltage installation.	Overhead wire, cable systems, etc.

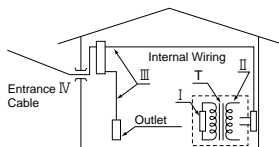

- EMC standards: Complies with EN61326.

The instrument continues to operate at a measuring accuracy of within $\pm 20\%$ of the range during tests.

Construction, Installation, and Wiring

- Construction: Dust-proof and drip-proof front panel conforming to IP55. For side-by-side close installation the controller loses its dust-proof and drip-proof protection.
- Material: ABS resin and polycarbonate
- Case color: Black
- Weight: About 1 kg or less
- Dimensions: 96 (W) × 96 (H) × 100 (depth from panel face) mm
- Installation: Panel-mounting type. With top and bottom mounting hardware (1 each)
- Panel cutout dimensions: $92^{+0.8}_0$ (W) × $92^{+0.8}_0$ (H) mm
- Installation position: Up to 30° upward facing (not designed for facing downward)
- Wiring: M3.5 screw terminals (for signal wiring and power/ground wiring as well)

Power Supply Specifications

- Power supply: Rated voltage of 100 to 240 V AC ($\pm 10\%$), 50/60 Hz
- Power consumption: Max. 20 VA (8.0 W max.)
- Internal fuse rating: 250 V AC, 1.6A time-lag fuse
- Data backup: Lithium cell with life expectancy of 10 years.
- Withstanding voltage
 - Between primary terminals* and secondary terminals**:
At least 1500 V AC for 1 minute
 - Between primary terminals* and grounding terminal:
At least 1500 V AC for 1 minute
 - Between grounding terminal and secondary terminals**:
At least 1500 V AC for 1 minute
 - Between secondary terminals**:
At least 500 V AC for 1 minute
- * Primary terminals indicate power terminals and relay output terminals
- ** Secondary terminals indicate analog I/O signal, voltage pulse output, and contact input terminals
- Insulation resistance: 20 M Ω or more at 500 V DC between power terminals and grounding terminal
- Grounding: Class D grounding (grounding resistance of 100 Ω or less)

Signal Isolations

- PV input terminals for Primary-loop: Isolated from PV input terminals for Secondary-loop and other input/output terminals. Not isolated from the internal circuit.
- PV input terminals for Secondary-loop: Isolated from PV input terminals for Primary-loop and other input/output terminals and internal circuit.
- Auxiliary analog input terminals: Isolated from other input/output terminals and the internal circuit.
- 15 V DC loop power supply terminals: Not isolated from analog current output and voltage pulse control output. Isolated from other input/output terminals and internal circuit.
- Analog output terminals (for control output and retransmission): Not isolated between analog outputs and from 15 V DC loop power supply and voltage pulse control output. Isolated from other input/output terminals and internal circuit.
- Voltage pulse control output terminals: Not isolated from analog outputs and 15 V DC loop power supply. Isolated from other input/output terminals and internal circuit.
- Relay contact control output terminals: Isolated between contact output terminals and from other input/output terminals and internal circuit.
- Contact input terminals: Not isolated between contact input terminals and from communication terminals. Isolated from other input/output terminals and internal circuit.
- Relay contact output terminals: Not isolated between relay contact outputs. Isolated from other input/output terminals and internal circuit.
- Transistor contact output terminals: Not isolated between transistor contact outputs. Isolated from other input/output terminals and internal circuit.

- RS-485 communication terminals: Not isolated from contact input terminals. Isolated from other input/output terminals and internal circuit.
- Power terminals: Isolated from other input/output terminals and internal circuit.
- Grounding terminals: Isolated from other input/output terminals and internal circuit.

Environmental Conditions

- Normal operating conditions:
 - Ambient temperature: 0 to 50°C (40°C or less for side-by-side close installation)
 - Temperature change rate: 10°C/h or less
 - Ambient humidity: 20 to 90% RH (no condensation allowed)
 - Magnetic field: 400 A/m or less
 - Continuous vibration at 5 to 14 Hz: Full amplitude of 1.2 mm or less
 - Continuous vibration at 14 to 150 Hz: 4.9 m/s² or less
 - Short-period vibration: 14.7 m/s², 15 seconds or less
 - Shock: 147 m/s² or less, 11 ms
 - Installation height: Height above sea level of 2000 m or less
 - Warm-up time: 30 minutes or more after power on
- Transportation and storage conditions:
 - Temperature: -25 to 70°C
 - Temperature change rate: 20°C/h or less
 - Humidity: 5 to 95% RH (no condensation allowed)
- Effects of changes in operating conditions
 - Effects from changes in ambient temperature:
 - On voltage or thermocouple input, $\pm 1 \mu\text{V}/^\circ\text{C}$ or $\pm 0.01\%$ of F.S./ $^\circ\text{C}$, whichever is larger
 - On auxiliary analog input, $\pm 0.02\%$ of F.S./ $^\circ\text{C}$
 - On RTD input, $\pm 0.05^\circ\text{C}/^\circ\text{C}$ (ambient temperature) or less
 - On analog output, $\pm 0.05\%$ of F.S./ $^\circ\text{C}$ or less
 - Effects from power supply fluctuation (within rated voltage range)
 - On analog input, $\pm 1 \mu\text{V}/10 \text{ V}$ or $\pm 0.01\%$ of F.S./10 V, whichever is larger
 - On analog output, $\pm 0.05\%$ of F.S./10 V or less

1.5 Terminal Wiring Diagrams



NOTE

Do not use unassigned terminals as relay terminals.

Terminal wiring diagrams are shown on and after the next page.

■ UT750 Cascade Control with Two Universal Inputs (Model UT750-50 or UT750-51)

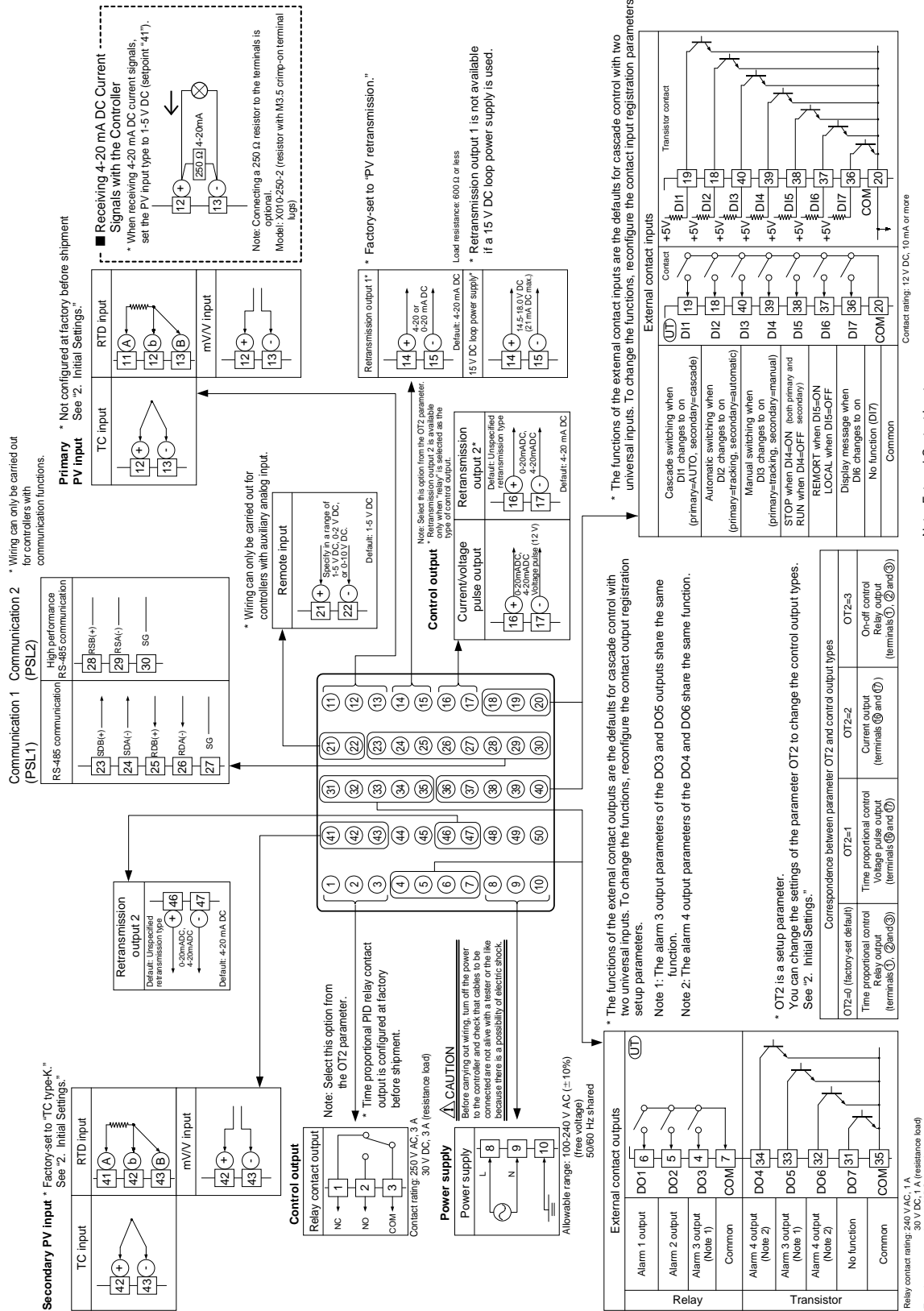

UT750 Cascade Heating/Cooling Control with Two Universal Inputs (Model UT750-50 or UT750-51)

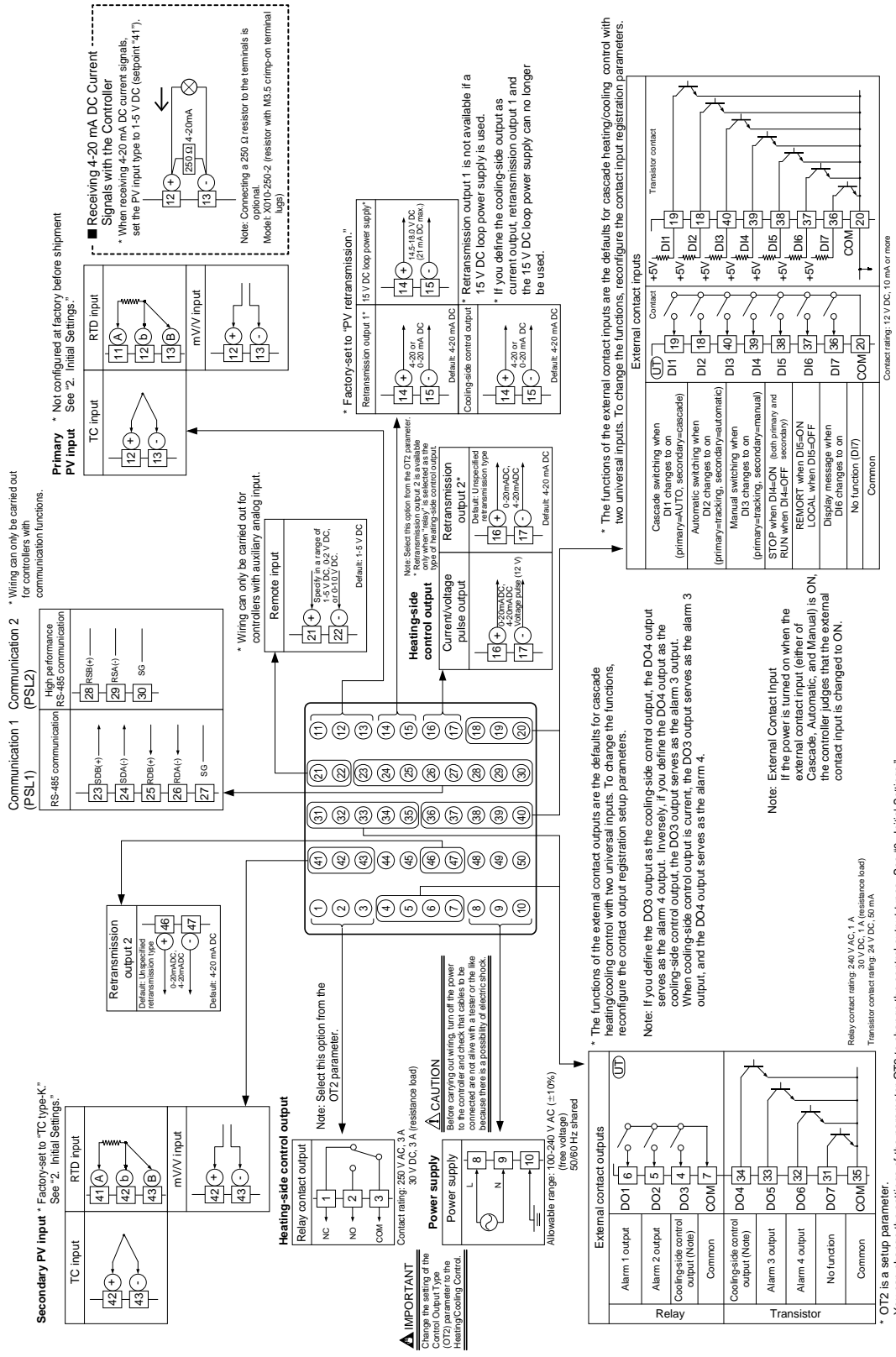

* OT2 is a setup parameter. You can change the settings of the parameter OT2 to change the control output types. See "2. Initial Settings."

Correspondence between parameter OT2 and heating-side output types/cooling-side output types

OT2-4	OT2-5	OT2-6	OT2-7	OT2-8	OT2-9	OT2-10	OT2-11	OT2-12
Heating side: Relay output (terminals ② and ③) Cooling side: Relay output (terminals ④ and ⑤)	Heating side: Voltage pulse output (terminals ⑥ and ⑦) Cooling side: Voltage pulse output (terminals ⑧ and ⑨)	Heating side: Current output (terminals ⑩ and ⑪) Cooling side: Current output (terminals ⑫ and ⑬)	Heating side: Relay output (terminals ⑭ and ⑮) Cooling side: Relay output (terminals ⑯ and ⑰)	Heating side: Voltage pulse output (terminals ⑱ and ⑲) Cooling side: Voltage pulse output (terminals ⑳ and ㉑)	Heating side: Current output (terminals ㉒ and ㉓) Cooling side: Current output (terminals ㉔ and ㉕)	Heating side: Relay output (terminals ㉖ and ㉗) Cooling side: Relay output (terminals ㉘ and ㉙)	Heating side: Voltage pulse output (terminals ㉚ and ㉛) Cooling side: Voltage pulse output (terminals ㉜ and ㉝)	Heating side: Current output (terminals ㉞ and ㉟) Cooling side: Current output (terminals ㊱ and ㊲)

The types of control output, "relay output" and "voltage pulse output" shown in the table above refer to those of time proportional control. To change to a relay output for on-off control, select "Relay terminals" and change the setpoint of the proportional band to "0".

Blank Page



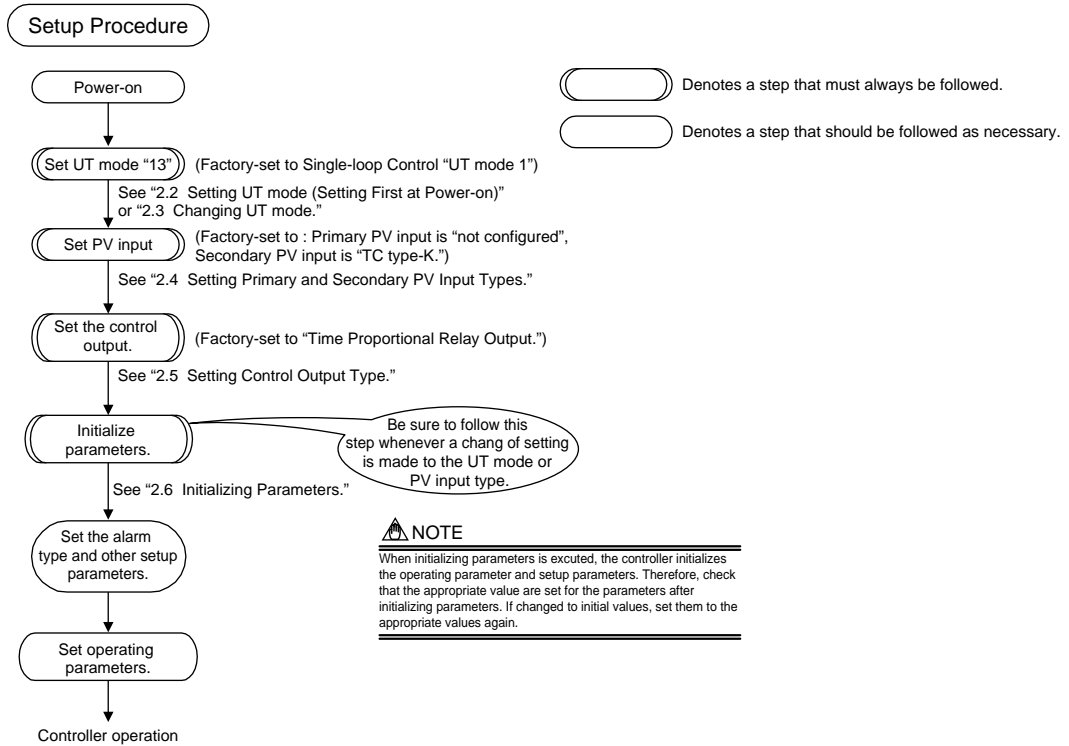

2. Initial Settings

This chapter describes examples of setting PV input types, control output types, and alarm types. Carrying out settings described herein allows you to perform basic control. Refer to examples of various settings to understand how to set parameters required. Refer to “5.1 Parameter Map” for an easy to understand explanation of setting various parameters. If you cannot remember how to carry out an operation during setting, press the **DISP** key no more than four times. This brings you to the display (operating display) that appears at power-on.

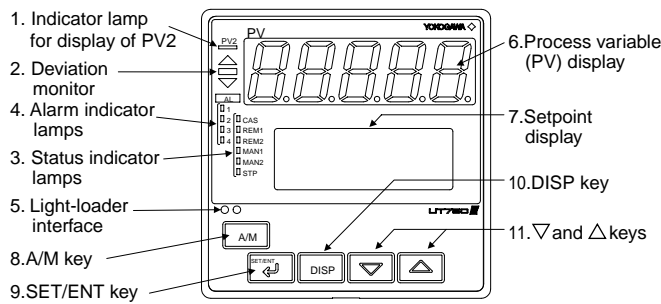

2.1 Names and Functions of Front Panel Parts



Name of Part	Function
1. Indicator lamp for display of PV2	Is lit when secondary PV is displayed on PV display.
2. Deviation monitor	When lit, indicates the status of a deviation (PV - SP). △: Is lit (in orange) if a deviation exceeds the deviation display range. □: Is lit (in green) when a deviation is within the deviation display range. ∇: Is lit (in orange) if a deviation falls below the deviation display range. The deviation monitor goes off if any display other than the operating display or SELECT display is shown.
3. Status indicator lamps	Is lit (in green) to indicate the status of operation or control. CAS: Is lit when in cascade mode. REM1: Is lit when in remote mode. REM2: Not used in cascade control with two universal inputs. MAN1: Is lit when in manual mode. Blinks during auto-tuning of the primary-loop. MAN2: Blinks during auto-tuning of the secondary-loop. STP: Is lit when operation stopped. Is unlit when a setup parameter setting display is shown.
4. Alarm indicator lamps	If any of alarms 1 to 4 occurs, the respective alarm indicator lamp (AL1 to AL4) is lit (in orange).
5. Light-loader interface	Interface for an adapter cable used when setting and storing parameters from a PC. This requires an optional parameter setting tool.
6. Process variable (PV) display	Displays PV. Displays an error code (in red) if an error occurs.
7. Setpoint display (LCD)	Displays the name and value of a target setpoint (SP), output (OUT), deviation (DV), deviation trend, or a parameter. Displays an error code if the controller fails.
8. A/M key	 Used to switch between the AUTO and MAN modes. Each time you press the key, it switches to the AUTO or MAN mode alternately.
9. SET/ENT key	 Used to switch or register a parameter. Pressing the key for more than 3 second allows you to switch between the operating display and the main menu for operating parameter setting display alternately.
10. DISP key	 Used to switch between displays. Pressing this key while any operating display is shown lets you switch to another prearranged operating display. Pressing this key while any display other than an operating display is shown lets you go back one display. (One to four presses (maximum) of this key lets you return to the current operating display, though the number of presses depends on the operating status.)
11. ∇ and ∆ keys	 Used to change numerical values. On setting displays for various parameters, you can change target setpoints, parameters, and output values (in manual operation). Pressing the ∇ key decreases a numerical value, while pressing the ∆ key causes it to increase. You can hold down a key to gradually increase the speed of change. These keys also switch between menu displays when a main menu or submenu of parameter setting display is shown.

2.2 Setting UT mode (Setting First at Power-on)

NOTE

- The controller displays an operating display when the power is turned on. The submenu "IN" appears at this point if the type of PV input has not been defined yet. In this case, set a UT mode to "Cascade Control with Two Universal Inputs," following the operating procedure described below. Then, set PV input type, control output type and others.
- The controller is configured to the default of each parameter at the factory before shipment. First check these defaults listed in "5.2 Lists of Parameters" and change their values if necessary.

The following operation describes a procedure of setting a UT mode to "Cascade Control with Two Universal Inputs." (set "13")

1. Display view at power on

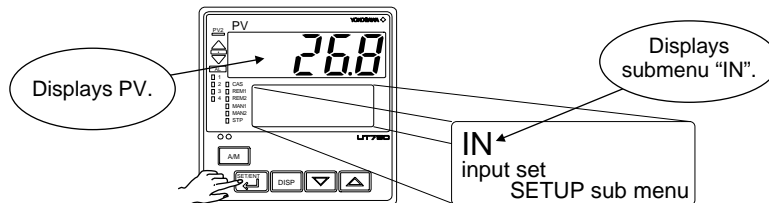

In steps 2 and later, illustrations of the LCD are cited to explain the procedure.

2. Press the key once to display the submenu "MD".

MD
UT mode set
SETUP sub menu

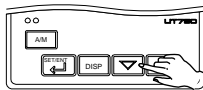

3. Press the key once to display the parameter "UTM" (controller mode).

MENU:UTMD/MD #1
UT mode select
UTM = SETUP
1

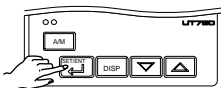

4. Press the or key to display the setpoint "13".

MENU:UTMD/MD #1
UT mode select
changing
UTM = 13

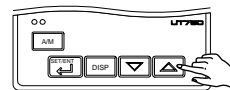

- 5. Press the  key once to register the setpoint "13".

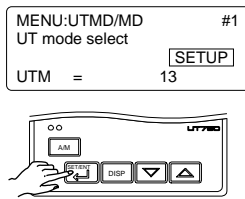

- 6. The controller re-starts (which is normal). Then, set the primary and secondary PV input types. See "2.4 Setting Primary and Secondary PV Input Types."



2.3 Changing UT mode

The following operation describes a procedure of changing a UT mode to "Cascade Control with Two Universal Inputs." (set "13")

- 1. Bring the operating display into view (display appears at power-on).

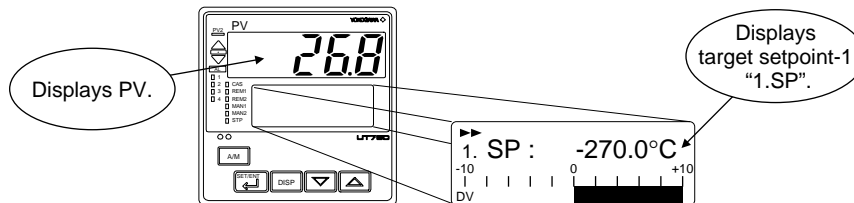

In steps 2 and later, illustrations of the LCD are cited to explain the procedure.

- 2. Press the  key for more than 3 seconds to call up the main menu "MODE".

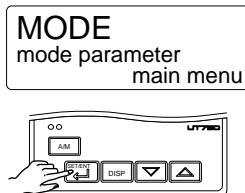

- 4. Press the  key once to display the main menu "LOOP1".

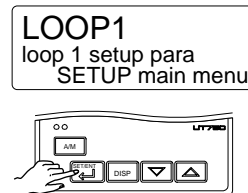

- 3. Press the  key once to display the main menu "STUP".

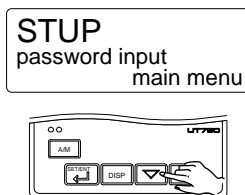

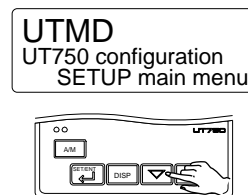

- 5. Press the  key once to display the main menu "UTMD".

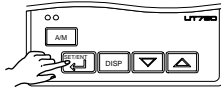

- 6. Press the  key once to display the submenu "MD".

MD
UT mode set
SETUP main menu



- 7. Press the  key once to display the parameter "UTM".

MENU:UTMD/MD #1
UT mode select
UTM =  1

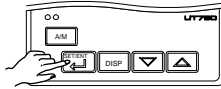

- 8. Press the  or  key to display the setpoint "13".

MENU:UTMD/MD #1
UT mode select
UTM = 13 changing

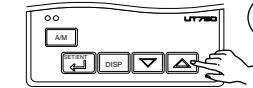

Blinks during change.

- 9. Press the  key once to register the setpoint.

MENU:UTMD/MD #1
UT mode select
UTM = 13 

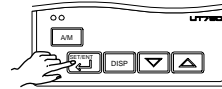

- 10. The controller re-starts (which is normal). Then, set PV input type. See "2.4 Setting Primary and Secondary PV Input Types."

IN
input set
SETUP sub menu

2.4 Setting Primary and Secondary PV Input Types

The following operating procedure describes an example of setting the primary PV input type to K-type thermocouple (-200.0 to 500.0°C) and measurement range of 0.0 to 200.0°C.

You can take the same steps for the secondary PV input type (IN2), PV input rang (RH2, RL2) (and PV input scale (SH2, SL2)) that are displayed after the primary-loop related parameters.

Primary PV input (Factory-set default: Not specified)

PV input terminal	
Thermocouple/mV/V input.....	⑫-⑬
RTD input	⑪-⑫-⑬

Secondary PV input (Factory-set default: typeK1)

PV input terminal	
Thermocouple/mV/V input.....	⑫-⑬
RTD input	④-⑫-⑬

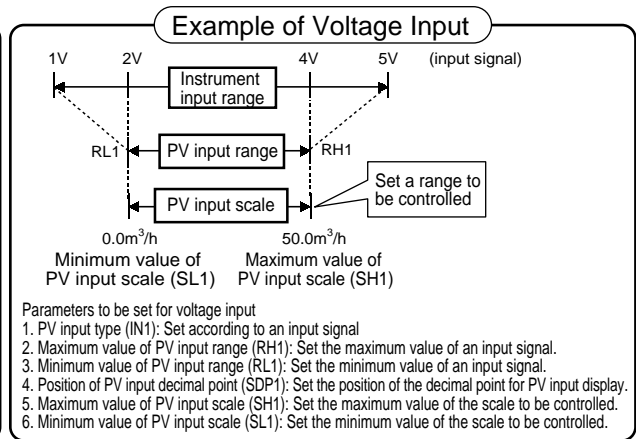
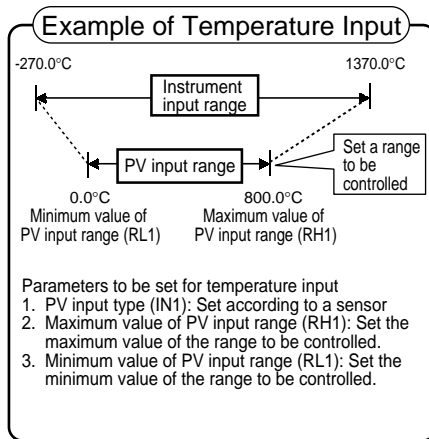

NOTE

The controller may automatically initialize the registered operating parameter setpoints if any change is made to the data item PV Input Type (IN1), Maximum Value of PV Input Range (RH1), Minimum Value of PV Input Range (RL1), PV Input Decimal Point Position (SDP1), Maximum Value of PV Input Scale (SH1) or Minimum Value of PV Input Scale (SL1). After a change has been made to any of these data items, be sure to verify the registered operating parameter setpoints to ensure that they are correct. If any data item has been changed to its default, set it to a required value.

1. Bring the operating display into view (display appears at power-on). The PV display in the figure below shows the error code for input burnout (*b.o.u.t*) if PV input wiring is not yet complete. The error code disappears when you wire the PV input terminals correctly.

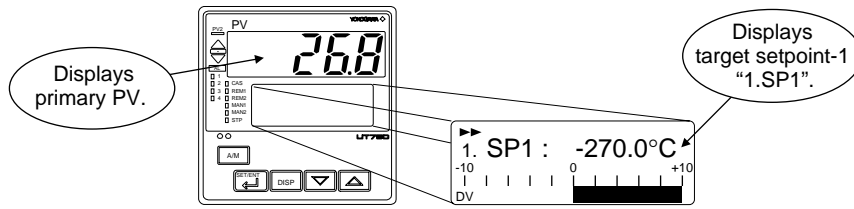

In steps 2 and later, illustrations of the LCD are cited to explain the procedure.

2. Press the key for more than 3 seconds to call up the main menu "MODE".

MODE
mode parameter
main menu

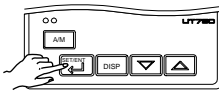

3. Press the key once to display the main menu "STUP".

STUP
password input
main menu

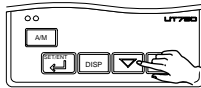

4. Press the key once to display the main menu "LOOP1".

LOOP1
loop 1 setup para
SETUP main menu

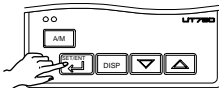

5. Press the key once to display the main menu "UTMD".

UTMD
UT750 configuration
SETUP main menu

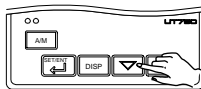

6. Press the key once to display the submenu "MD".

MD
UT mode set
SETUP main menu

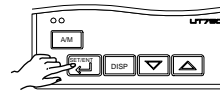

7. Press the key once to display the submenu "IN".

IN
input set
SETUP sub menu

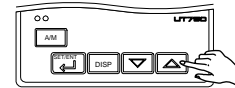

8. Press the key once to display the parameter "IN1" (primary PV input type).

MENU:UTMD/IN #1
input 1 type select
IN1 = OFF

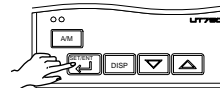

9. Press the or key to display the required setpoint. The figure below shows an example of setting the PV input type to a K-type thermocouple (-200.0°C to 500.0°C).

MENU:UTMD/IN #1
input 1 type select
IN1 = typeK3

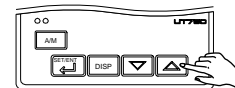

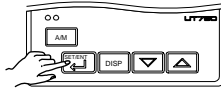
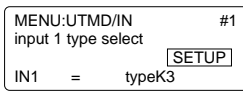

Blinks during change.

- 10. Press the  key once to register the setpoint.



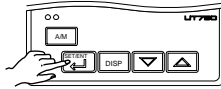
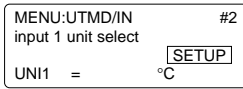

- 11. Press the  key once to display the parameter "UNI1" (primary PV input unit).

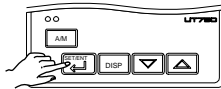
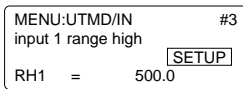

- 12. Press the  key once to display the parameter "RH1" (maximum value of primary PV input range).



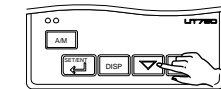
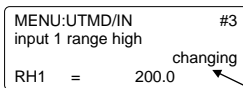

- 13. Press the  or  key to display the required setpoint. The figure below shows an example of setting the maximum value of the PV input range to 200.0°C.



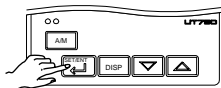
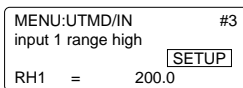

Blinks during change.

- 14. Press the  key once to register the setpoint.

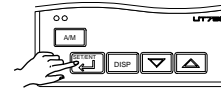
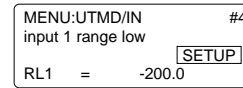

- 15. Press the  key once to display the parameter "RL1" (minimum value of primary PV input range).



- 16. Press the  or  key to display the required setpoint. The figure below shows an example of setting the minimum value of the PV input range to 0.0°C.

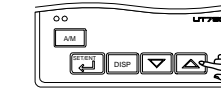
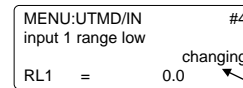

Blinks during change.

- 17. Press the  key once to register the setpoint.

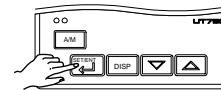
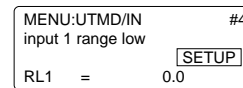

If the type of input is voltage, also configure the Primary PV Input Decimal Point Position (SDP1), Maximum Value of Primary PV Input Scale (SH1) and Minimum Value of Primary PV Input Scale (SL1) parameters that are displayed after this.

- 18. Press the  key for more than 3 seconds. This returns you to the display shown at power-on (figure below).

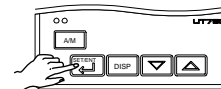
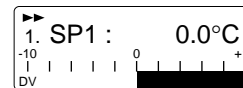

Instrument Input Range Codes

Input	Type	Instrument Input Range Code	Instrument Input Range	Measurement Accuracy
Unspecified		OFF (0)	Set the data item PV Input Type "IN1" to the OFF option to leave the PV input type undefined.	
Thermocouple	K	typeK1 (1)	-270.0 to 1370.0°C -450.0 to 2500.0°F	±0.1% of instrument range ±1 digit at 0°C or more ±0.2% ±1 digit for temperatures below 0°C, where the accuracy is: ±2% of instrument range ±1 digit for temperatures below -200.0°C for a type-K thermocouple, or ±1% of instrument range ±1 digit for temperatures below -200.0°C for a type-T thermocouple. ±0.15% of instrument range ±1 digit at 400°C or more ±5% of instrument range ±1 digit at less than 400°C ±0.15% of instrument range ±1 digit ±0.1% of instrument range ±1 digit ±0.25% of instrument range ±1 digit for temperatures below 0°C ±0.1% of instrument range ±1 digit at 0°C or more ±0.2% ±1 digit for temperatures below 0°C, where the accuracy is: ±1.5% of instrument range ±1 digit for temperatures below -200.0°C for a type-E thermocouple. ±0.2% of instrument range ±1 digit ±0.1% of instrument range ±1 digit ±0.5% of instrument range ±1 digit at 800°C or more No accuracy is guaranteed at less than 800°C ±0.2% of instrument range ±1 digit
		typeK2 (2)	-270.0 to 1000.0°C -450.0 to 2300.0°F	
		typeK3 (3)	-200.0 to 500.0°C -200.0 to 1000.0°F	
	J	typeJ (4)	-200.0 to 1200.0°C -300.0 to 2300.0°F	
	T	typeT1 (5)	-270.0 to 400.0°C -450.0 to 750.0°F	
		typeT2 (6)	0.0 to 400.0°C -200.0 to 750.0°F	
	B	typeB (7)	0.0 to 1800.0°C 32 to 3300°F	
	S	typeS (8)	0.0 to 1700.0°C 32 to 3100°F	
	R	typeR (9)	0.0 to 1700.0°C 32 to 3100°F	
	N	typeN (10)	-200.0 to 1300.0°C -300.0 to 2400.0°F	
	E	typeE (11)	-270.0 to 1000.0°C -450.0 to 1800.0°F	
	L(DIN)	typeL (12)	-200.0 to 900.0°C -300.0 to 1600.0°F	
	U(DIN)	typeU1 (13)	-200.0 to 400.0°C -300.0 to 750.0°F	
		typeU2 (14)	0.0 to 400.0°C -200.0 to 1000.0°F	
	W	typeW (15)	0.0 to 2300.0°C 32 to 4200°F	
	Platinel 2	Plati2 (16)	0.0 to 1390.0°C 32 to 2500.0°F	
	PR20-40	PR2040 (17)	0.0 to 1900.0°C 32 to 3400°F	
	W97Re3-W75Re25	W97Re3 (18)	0.0 to 2000.0°C 32 to 3600°F	
RTD	JPt100	JPt1 (30)	-200.0 to 500.0°C -300.0 to 1000.0°F	
		JPt2 (31)	-150.00 to 150.00°C -200.0 to 300.0°F	
	Pt100	Pt1 (35)	-200.0 to 850.0°C -300.0 to 1560.0°F	
		Pt2 (36)	-200.0 to 500.0°C -300.0 to 1000.0°F	
		Pt3 (37)	-150.00 to 150.00°C -200.0 to 300.0°F	
Standard signal	0.4 to 2 V 1 to 5 V	0.4 to 2 V (40) 1 to 5 V (41)	0.400 to 2.000 V 1.000 to 5.000 V	
DC voltage	0 to 2 V 0 to 10 V	0 to 2 V (50) 0 to 10 V (51)	0.000 to 2.000 V 0.00 to 10.00 V	
	0.00 to 1.25 V (Note 3)	0.00 to 1.25 V (52)	0.000 to 1.250 V	
	-10 to 20 mV	mV1 (55)	-10.00 to 20.00 mV	
	0 to 100 mV	mV2 (56)	0.0 to 100.0 mV	

Performance in the standard operating conditions (at 23±2°C, 55±10%RH, and 50/60 Hz power frequency)

Note 1: The accuracy is ±0.3°C of instrument range ±1 digit for a temperature range from 0°C to 100°C.

Note 2: The accuracy is ±0.5°C of instrument range ±1 digit for a temperature range from -100°C to 200°C.

Note 3: Only used in secondary-loop (IN2).

* To receive a 4-20 mA DC signal, select a standard signal of 1 to 5 V DC and connect it to a 250 Ω resistor. This resistor is optional.

Model: X010-250-2 (resistor with M3.5 crimp-on terminal lugs)

2.5 Setting Control Output Type

The following operating procedure describes an example of changing time proportional PID relay output (0: factory-set default) to current output (2).

Control output terminal Values in parentheses are setpoints

Time proportional PID relay (0)/on-off(3) output..... ①-②-③

Current (2)/time proportional PID voltage pulse (1) output..... ⑩-⑪

For details on the output terminals for heating/cooling control, see "1.5 Terminal Wiring Diagrams".

1. Bring the operating display into view (display appears at power-on).

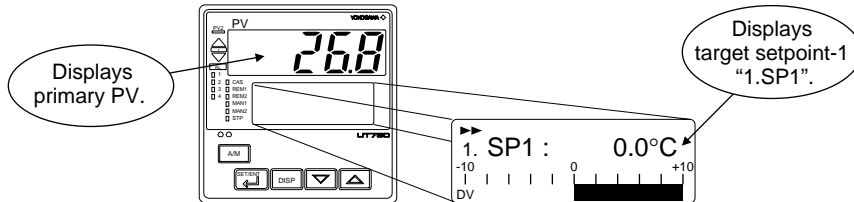

In steps 2 and later, illustrations of the LCD are cited to explain the procedure.

2. Press the key for more than 3 seconds to call up the main menu "MODE".

MODE
mode parameter
main menu

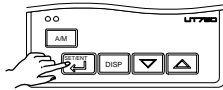

3. Press the key once to display the main menu "STUP".

STUP
password input
main menu

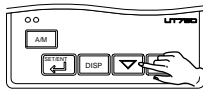

4. Press the key once to display the main menu "LOOP1".

LOOP1
loop 1 setup para
SETUP main menu

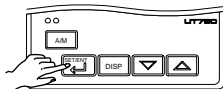

5. Press the key once to display the main menu "UTMD".

UTMD
UT750 configuration
SETUP main menu

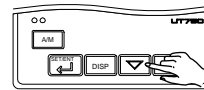

6. Press the key once to display the submenu "MD".

MD
UT mode set
SETUP sub menu

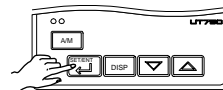

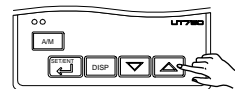

7. Press the key twice to display the submenu "OUT".

OUT
output set
SETUP sub menu

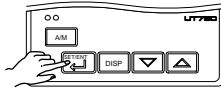
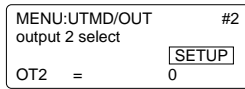

8. Press the  key once to display the parameter "OT2" (control output type).



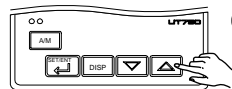
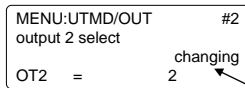

9. Press the  or  key to display the required setpoint. The figure below shows an example of setting to current output (4 to 20 mA DC).

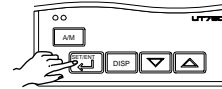
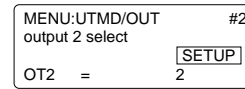

Blinks during change.

10. Press the  key once to register the setpoint.



11. Press the  key for **more than 3 seconds**. This returns you to the display shown at power-on (figure below).

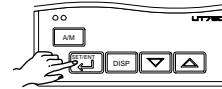

● List of Control Output Types

Parameter Symbol	Name of Parameter	Setpoint	Control Output Types
OT2	Control output type	0	Time proportional PID relay contact output (terminals ① - ② - ③)
		1	Time proportional PID voltage pulse output (terminals ⑯ - ⑰)
		2	Current output (terminals ⑯ - ⑰)
		3	On/off control relay contact output (terminals ① - ② - ③)
		4	Heating-side relay output (terminals ① - ② - ③), cooling-side relay output (terminals ④ - ⑦)
		5	Heating-side pulse output (terminals ⑯ - ⑰), cooling-side relay output (terminals ④ - ⑦)
		6	Heating-side current output (terminals ⑯ - ⑰), cooling-side relay output (terminals ④ - ⑦)
		7	Heating-side relay output (terminals ① - ② - ③), cooling-side transistor output (terminals ⑱ - ⑳)
		8	Heating-side pulse output (terminals ⑯ - ⑰), cooling-side transistor output (terminals ⑱ - ⑳)
		9	Heating-side current output (terminals ⑯ - ⑰), cooling-side transistor output (terminals ⑱ - ⑳)
		10	Heating-side relay output (terminals ① - ② - ③), cooling-side current output (terminals ⑭ - ⑮)
		11	Heating-side pulse output (terminals ⑯ - ⑰), cooling-side current output (terminals ⑭ - ⑮)
12	Heating-side current output (terminals ⑯ - ⑰), cooling-side current output (terminals ⑭ - ⑮)		

2.6 Initializing Parameters

Be sure to follow the steps below after a change of setting has been made to the data item PV Input Type, PV Input Range or PV Input Scale.



Initializing the above parameter setpoints may initialize the registered operating/setup parameters. Check that they are correct. If any of them has been changed to its initial value, set it to a required value.

- 1. Bring the operating display into view (display appears at power-on).

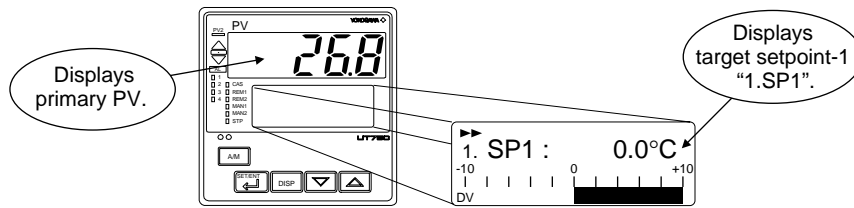

In steps 2 and later, illustrations of the LCD are cited to explain the procedure.

- 2. Press the  key for more than 3 seconds to call up the main menu "MODE".

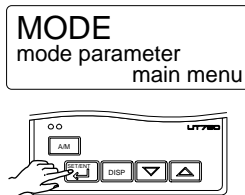

- 3. Press the  key once to display the main menu "STUP".

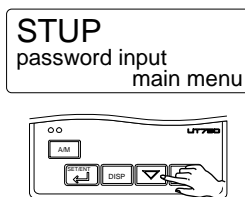

- 4. Press the  key once to display the main menu "LOOP1".

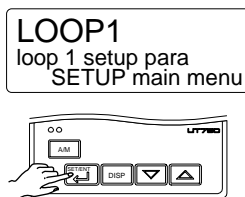

- 5. Press the  key once to display the main menu "UTMD".

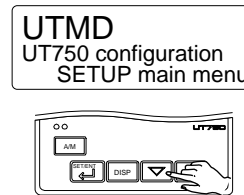

- 6. Press the  key once to display the submenu "MD".

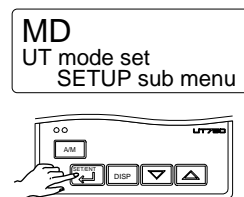

- 7. Press the  key twice to display the submenu "INIT".

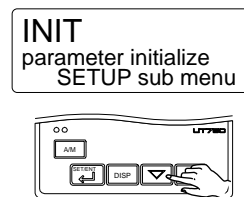

- 8. Press the  key once to display the parameter "INI".

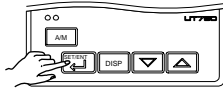
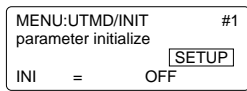

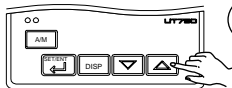
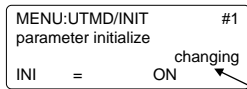

- 9. Press the  key to display "ON".

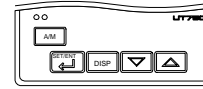
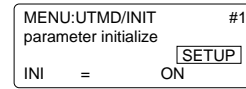

Blinks during change.

- 10. Press the  key once. The display momentarily becomes blank (which is normal), indicating the parameters have been initialized.



- 11. Press the  key for more than 3 seconds. This returns you to the display shown at power-on (figure below).

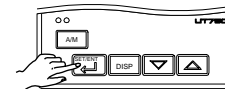
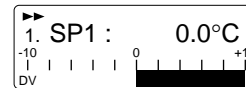

2.7 Changing Alarm Type of Primary-loop

The following operating procedure describes an example of changing alarm 1 (factory-set to the PV high limit alarm) to the PV low limit alarm.

When you have changed alarm type, the alarm setpoint will be initialized; set the alarm setpoint again.

Alarm output terminals	Factory-set default
Alarm-1 (terminal numbers ⑥-⑦)	PV high limit alarm
Alarm-2 (terminal numbers ⑥-⑦)	PV low limit alarm
Alarm-3 (terminal numbers ④-⑦)	PV high limit alarm
Alarm-4 (terminal numbers ④-⑤)	PV low limit alarm

- 1. Bring the operating display into view (display appears at power-on).

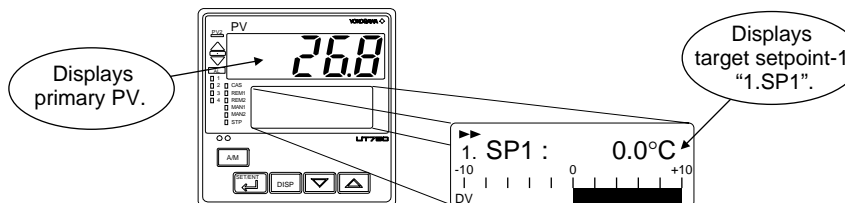

In steps 2 and later, illustrations of the LCD are cited to explain the procedure.

- 2. Press the  key for more than 3 seconds to call up the main menu "MODE".

MODE
mode parameter
main menu

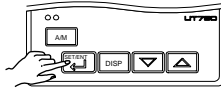

- 3. Press the  key once to display the main menu "STUP".

STUP
password input
main menu

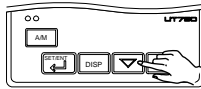

- 4. Press the  key once to display the main menu "LOOP1".

LOOP1
loop 1 setup para
SETUP main menu

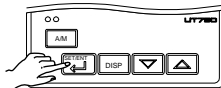

- 5. Press the  key once to display the submenu "SP".

SP
SP control
SETUP sub menu

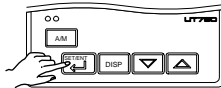

- 6. Press the  key once to display the submenu "ALM".

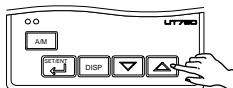

ALM
alarm control
SETUP sub menu

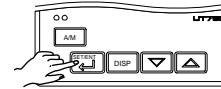

- 7. Press the  key once to display the parameter "AL1" (alarm-1 type).

MENU:LOOP1/ALM #1
alarm 1 type select
AL1 = 1



- 8. Press the  or  key to display the required setpoint. The figure below shows an example of setting the PV low limit alarm.

MENU:LOOP1/ALM #1
alarm 1 type select
AL1 = 2

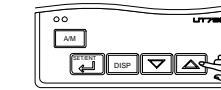

Blinks during change.

- 9. Press the  key once to register the setpoint.

MENU:LOOP1/ALM #1
alarm 1 type select
AL1 = 2

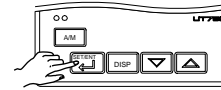

You can take the same steps for alarm-2 type (AL2), alarm-3 type (AL3), and alarm-4 type (AL4) that are displayed after this.

- 10. Press the  key for more than 3 seconds. This returns you to the display shown at power-on (figure below).

1. SP1 : 0.0°C
-10 | 0 | +10
DV

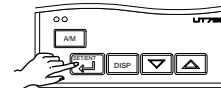

- 11. When setting alarm setpoints, see "3.8 Setting Alarm Setpoints of Primary-loop."

List of Alarm Types

The table below shows the alarm types and alarm actions.

In the table, codes 1 to 10 are not provided with stand-by actions, while codes 11 to 20 are provided with stand-by actions.

Alarm type	Alarm action "Open/close" shows status of relay contact, and "lit" and "unlit" shows status of lamp	Alarm type code		Alarm type	Alarm action "Open/close" shows status of relay contact, and "lit" and "unlit" shows status of lamp	Alarm type code	
		Contact closes if alarm occurs	Contact opens if alarm occurs			Contact closes if alarm occurs	Contact opens if alarm occurs
No alarm		OFF					
PV high limit		1	/	De-energized on deviation low limit alarm		/	6 16
		11					
PV low limit		2	/	Deviation high and low limits		/	7 17
		12					
Deviation high limit		3	/	Deviation within high and low limits		/	8 18
		13					
Deviation low limit		4	/	De-energized on PV high limit		/	9 19
		14					
De-energized on deviation high limit alarm		5	/	De-energized on PV low limit		/	10 20
		15					
Timer function (Alarm-1 only)	Upward (hour/minute)	21	/	Sensor grounding alarm	Sensor grounding alarm	/	25 26 27
	Downward (hour/minute)	22		Fault diagnosis output (Note1)	Fault diagnosis output		
	Upward (minute/second)	23		FAIL output (Note2)	The controller stops when in a FAIL state. The control output is set to "OFF" or "0%" and the alarm output is set to "OFF".		
	Downward (minute/second)	24					
SP high limit		28	/	Output high limit		/	30
SP low limit		29		Output low limit			

Note 1: The fault diagnosis output turns on in case of input burnout, A/D converter failure, or reference junction compensation (RJC) failure.

For input burnout or A/D converter failure, the control output is set to the setpoint of the Preset Output Value operating parameter (PO).

Note 2: The FAIL output is on during normal operation and turns off in case of failure.

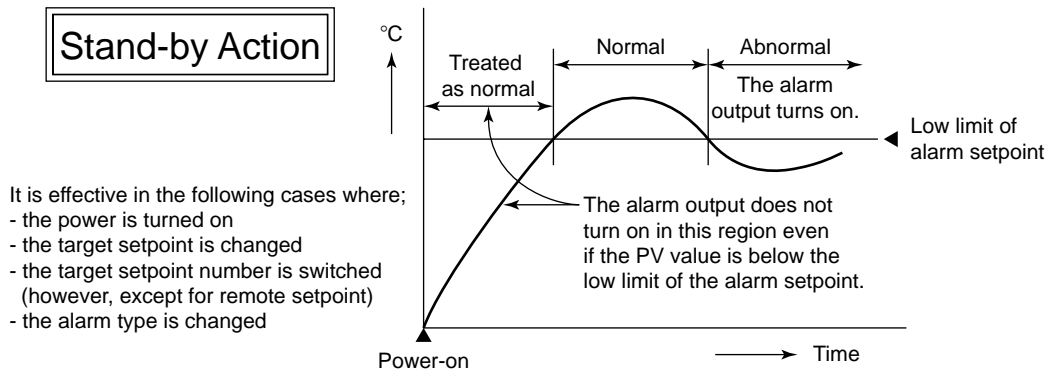

2.8 Description of Multiple Setpoints and PID

The UT750 has a maximum of eight target setpoints, and has PID for each of these setpoints. The following shows the correspondence between the target setpoint numbers (SPNO), target setpoints (SP), and PID parameters.

For example, if you have set “2” to the target setpoint number (SPNO), the control parameters available are target setpoint (2.SP), proportional band (heating-side proportional band) (2.P), integral time (heating-side integral time) (2.I), derivative time (heating-side derivative time) (2.D), cooling-side proportional band (2.Pc), cooling-side integral time (2.Ic), and cooling-side derivative time (2.Dc).

To use multiple target setpoints, see the table below to check the corresponding parameters.

● Target setpoint (SP) and PID parameter of Primary-loop

Target setpoint number (SPNO)	Target setpoint (SP)	PID parameter		
		Proportional band	Integral time	Derivative time
SPNO=1	1.SP	1.P	1.I	1.D
SPNO=2	2.SP	2.P	2.I	2.D
SPNO=3	3.SP	3.P	3.I	3.D
SPNO=4	4.SP	4.P	4.I	4.D
SPNO=5	5.SP	5.P	5.I	5.D
SPNO=6	6.SP	6.P	6.I	6.D
SPNO=7	7.SP	7.P	7.I	7.D
SPNO=8	8.SP	8.P	8.I	8.D

● Target setpoint (SP) and PID parameter of Secondary-loop

Target setpoint number (SPNO)	Target setpoint (SP)	PID parameter					
		Proportional band (heating-side proportional band)	Integral time (heating-side integral time)	Derivative time (heating-side derivative time)	Cooling-side proportional band	Cooling-side integral time	Cooling-side derivative time
SPNO=1	1.SP	1.P	1.I	1.D	1.Pc	1.Ic	1.Dc
SPNO=2	2.SP	2.P	2.I	2.D	2.Pc	2.Ic	2.Dc
SPNO=3	3.SP	3.P	3.I	3.D	3.Pc	3.Ic	3.Dc
SPNO=4	4.SP	4.P	4.I	4.D	4.Pc	4.Ic	4.Dc
SPNO=5	5.SP	5.P	5.I	5.D	5.Pc	5.Ic	5.Dc
SPNO=6	6.SP	6.P	6.I	6.D	6.Pc	6.Ic	6.Dc
SPNO=7	7.SP	7.P	7.I	7.D	7.Pc	7.Ic	7.Dc
SPNO=8	8.SP	8.P	8.I	8.D	8.Pc	8.Ic	8.Dc

* The target setpoint numbers (SPNO) of the primary-loop and the secondary-loop are the same.

3. Operations

This chapter describes key entries for operating the controller. For operations using external contact inputs, see “1.5 Terminal Wiring Diagrams.” If you cannot remember how to carry out an operation during setting, press the **DISP** key no more than four times. This brings you to the display (operating display) that appears at power-on.

3.1 Monitoring-purpose Operating Displays Available during Operation

The monitoring-purpose operating displays available during operation include those for cascade control with two universal inputs and those for cascade heating/cooling cascade control with two universal inputs.

■ Operating Displays for Cascade Control with Two Universal Inputs

○ In Cascade Operations

● SP Display (primary-loop)

The PV input value of the primary-loop appears on the PV display.

The target setpoint of the primary-loop (1.SP1), along with the deviation bar appears on the Setpoint display (LCD).

● SP Display (secondary-loop)

The PV input value of the secondary-loop appears on the PV display.

The cascade setpoint of the secondary-loop (C.SP2), along with the deviation bar appears on the Setpoint display (LCD).

● PV2/SP/OUT2 Display

The PV input value of the primary-loop appears on the PV display.

The PV value of the secondary-loop (PV2), target setpoint of the primary-loop (1.SP1), cascade setpoint (C.SP2), and control output value (OUT2) appears on the Setpoint display (LCD).

● Deviation Trend Display (primary-loop)

The PV input value of the primary-loop appears on the PV display.

The deviation trend appears on the Setpoint display (LCD).

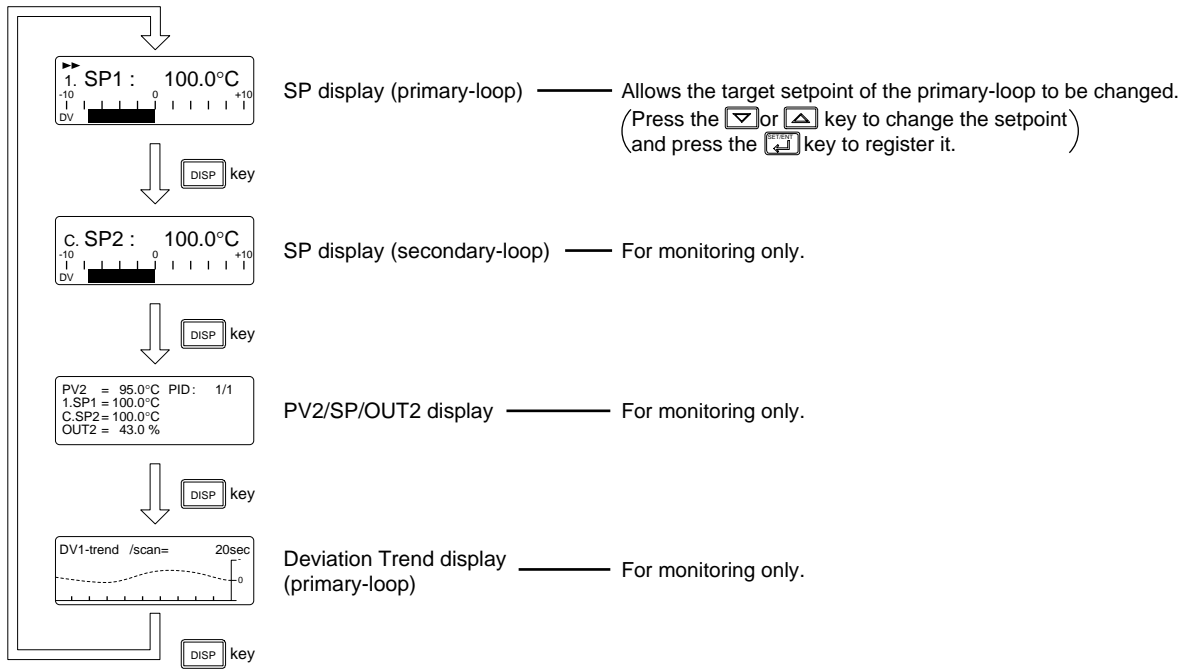

○ In Automatic/Manual Operations

● SP Display (primary-loop)

The PV input value of the primary-loop appears on the PV display.

The target setpoint of the primary-loop (1.SP1), along with the deviation bar appears on the Setpoint display (LCD).

● SP Display (secondary-loop)

The PV input value of the secondary-loop appears on the PV display.

The target setpoint of the secondary-loop (1.SP2), along with the deviation bar appears on the Setpoint display (LCD).

● PV2/SP/OUT2 Display

The PV input value of the primary-loop appears on the PV display.

The PV value of the secondary-loop (PV2), target setpoint of the primary-loop (1.SP1), target setpoint of the secondary-loop (1.SP2), and control output value (OUT2) appears on the Setpoint display (LCD).

● Deviation Trend Display (secondary-loop)

The PV input value of the secondary-loop appears on the PV display.

The deviation trend appears on the Setpoint display (LCD).

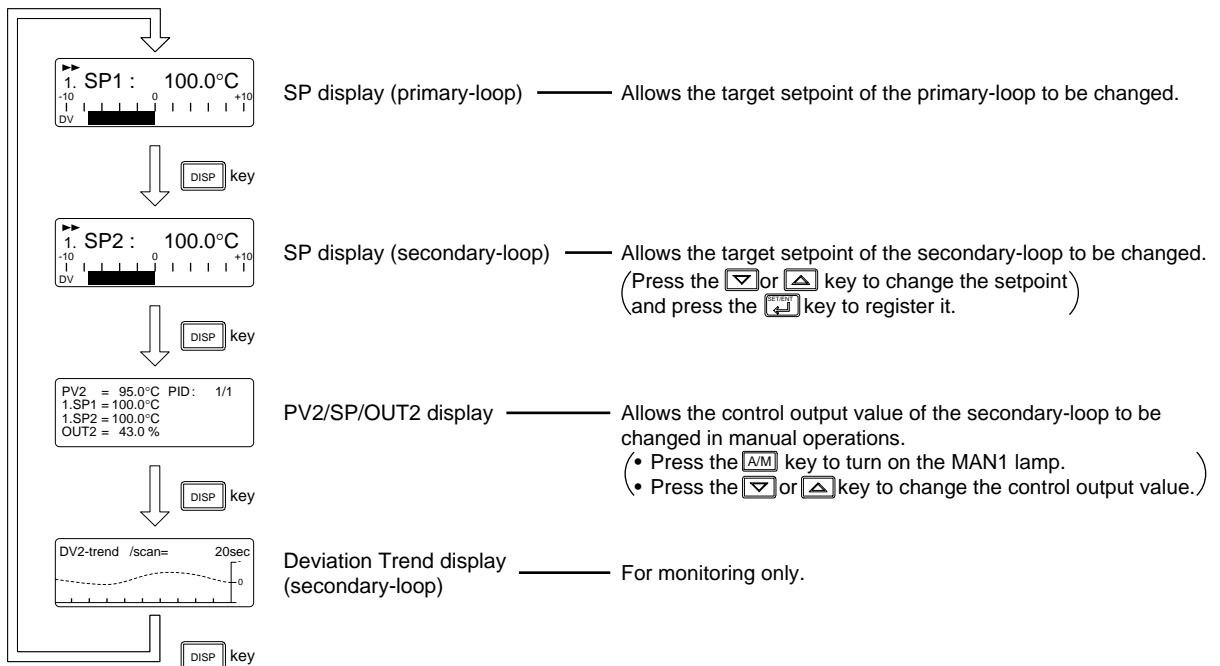

■ Operating Displays for Cascade Heating/Cooling Control with Two Universal Inputs

○ In Cascade Operations

● SP Display (primary-loop)

The PV input value of the primary-loop appears on the PV display.

The target setpoint of the primary-loop (1.SP1), along with the deviation bar appears on the Setpoint display (LCD).

● SP Display (secondary-loop)

The PV input value of the secondary-loop appears on the PV display.

The cascade setpoint of the secondary-loop (C.SP2), along with the deviation bar appears on the Setpoint display (LCD).

● Heating/Cooling PV2/SP/OUT2 Display

The PV input value of the primary-loop appears on the PV display.

The PV input value of the secondary-loop (PV2), target setpoint of the primary-loop (1.SP1), cascade setpoint (C.SP2), cooling-side control output value (C2), and heating-side control output value (H2) appears on the Setpoint display (LCD).

● Deviation Trend Display (primary-loop)

The PV input value of the primary-loop appears on the PV display.

The deviation trend appears on the Setpoint display (LCD).

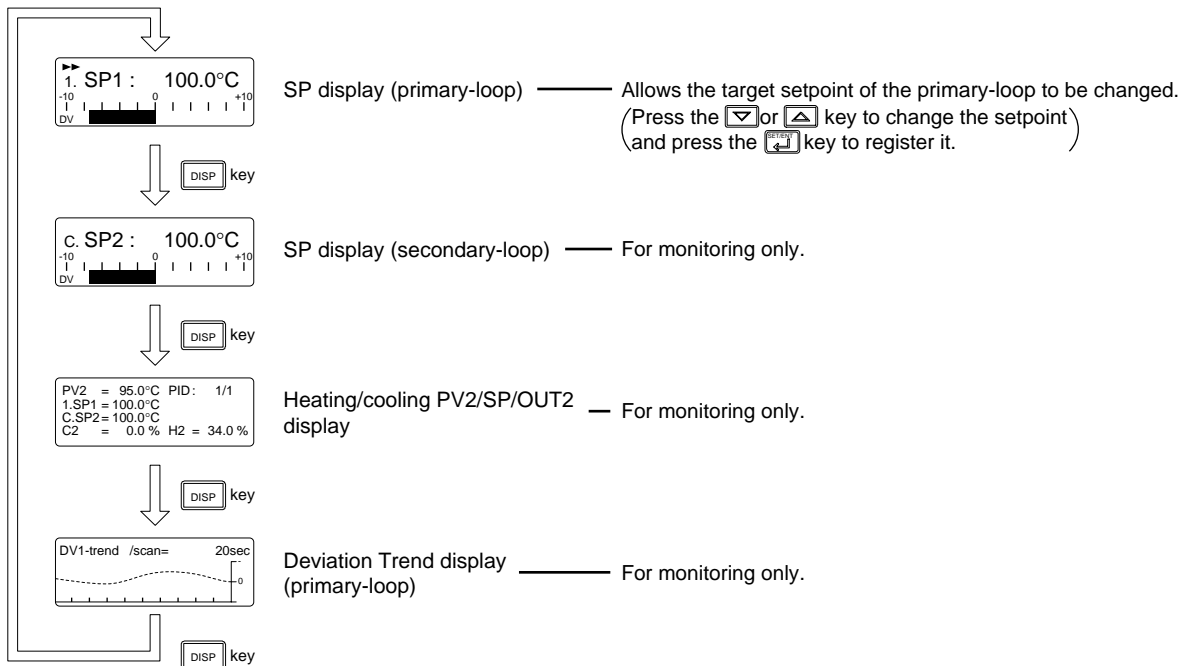

○ In Automatic/Manual Operations

● SP Display (primary-loop)

The PV input value of the primary-loop appears on the PV display.

The target setpoint of the primary-loop (1.SP1), along with the deviation bar appears on the Setpoint display (LCD).

● SP Display (secondary-loop)

The PV input value of the secondary-loop appears on the PV display.

The target setpoint of the secondary-loop (1.SP2), along with the deviation bar appears on the Setpoint display (LCD).

● Heating/Cooling PV2/SP/OUT2 Display

The PV input value of the primary-loop appears on the PV display.

The PV input value of the secondary-loop (PV2), target setpoint of the primary-loop (1.SP1), target setpoint of the secondary-loop (1.SP2), cooling-side control output value (C2), and heating-side control output value (H2) appears on the Setpoint display (LCD).

● Deviation Trend Display (secondary-loop)

The PV input value of the secondary-loop appears on the PV display.

The deviation trend appears on the Setpoint display (LCD).

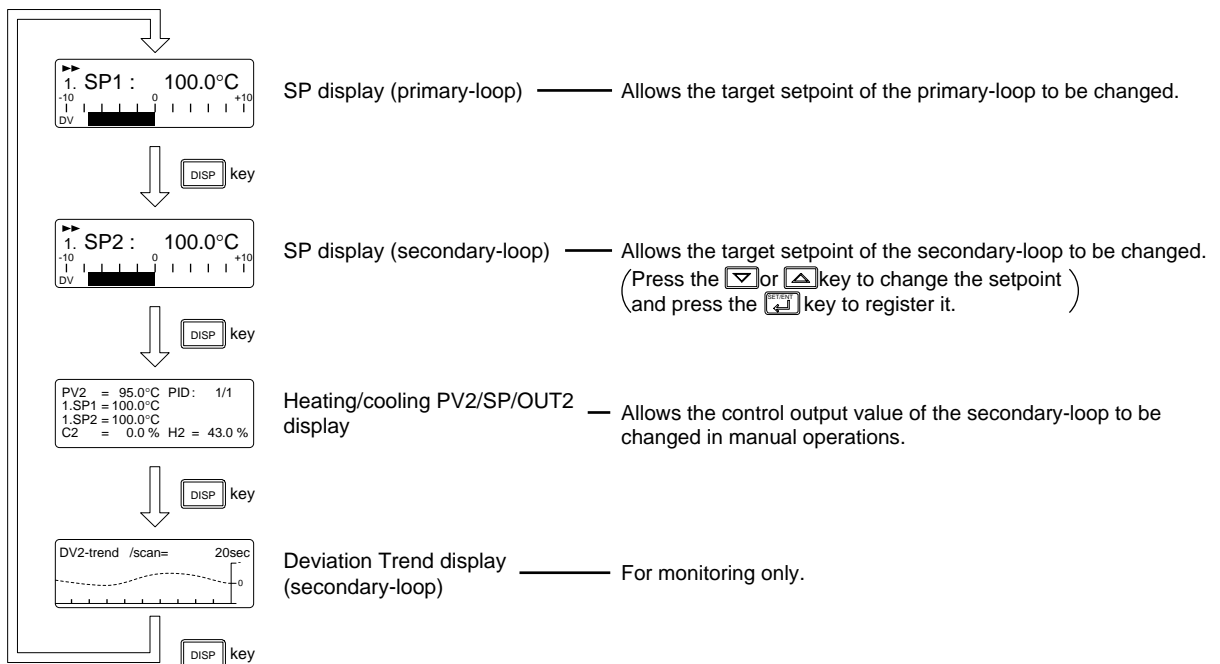

3.2 Setting Target Setpoint (SP) of Primary-loop

The following operating procedure describes an example of setting 150.0 to a target setpoint of the primary-loop during cascade operation.

1. Bring the operating display into view (display appears at power on).

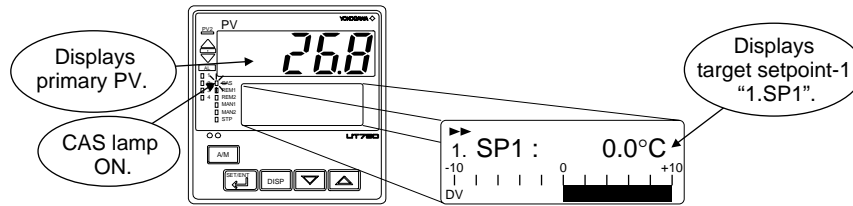

In steps 2 and later, illustrations of the LCD are cited to explain the procedure.

2. Press the or key to display the required setpoint.

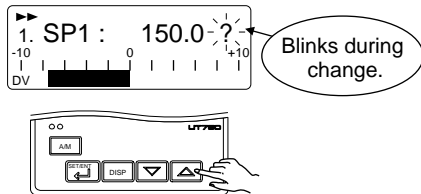

3. Press the key once to register the setpoint.

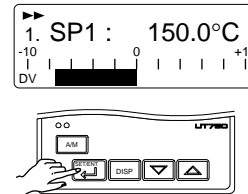

The following is the procedure to change the target setpoint of the primary-loop during any operating condition.

1. Bring the operating display into view (display appears at power on).

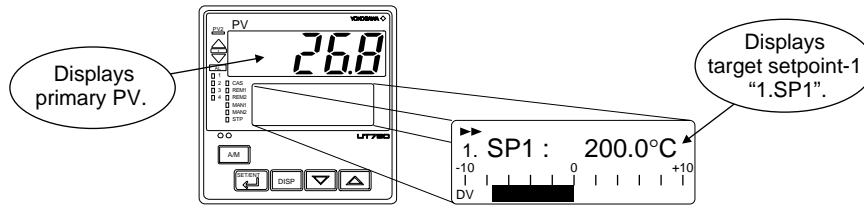

In steps 2 and later, illustrations of the LCD are cited to explain the procedure.

2. Press the key for more than 3 seconds to call up the main menu "MODE".

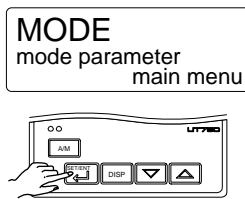

3. Press the key once to display the main menu "LP1".

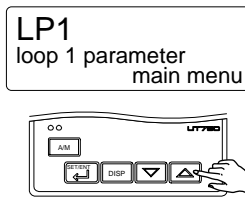

4. Press the key once to display the submenu "PAR".

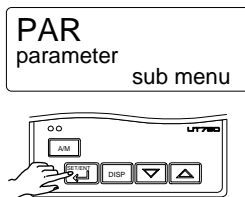

5. Press the key once to display the submenu "1.PID".

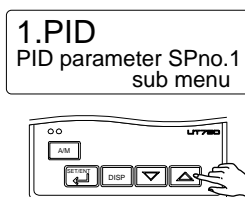

6. Press the key once to display the parameter "1.SP".

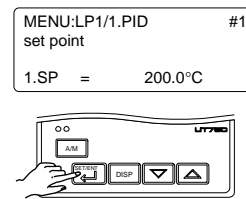

7. Press the or key to display the required setpoint.

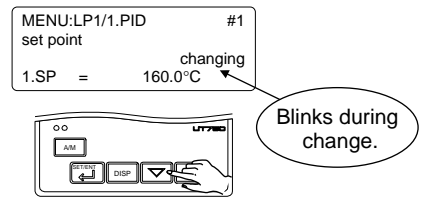

8. Press the key once to register the setpoint.

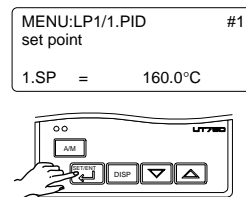

9. Press the key for more than 3 seconds. This returns you to the display shown at power-on (figure below).

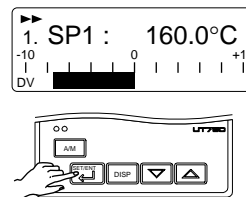

3.3 Setting Target Setpoint (SP) of Secondary-loop

The following operating procedure describes an example of setting 120.0 to a target setpoint of the secondary-loop during automatic or manual operation.

1. Bring the operating display into view (display appears at power on).

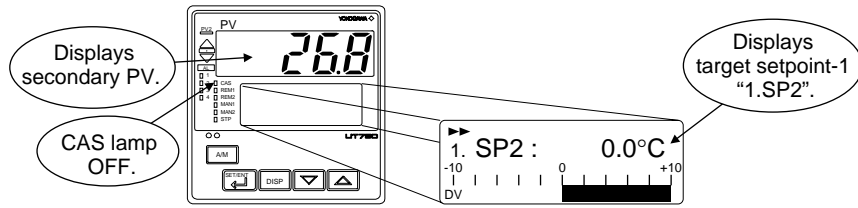

In steps 2 and later, illustrations of the LCD are cited to explain the procedure.

2. Press the or key to display the required setpoint.

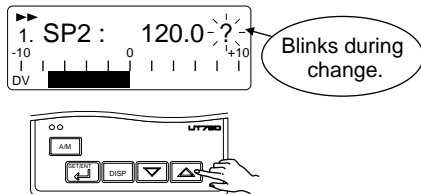

3. Press the key once to register the setpoint.

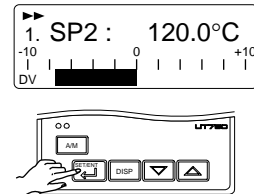

The following is the procedure to change the target setpoint of the secondary-loop during any operating conditions.

1. Bring the operating display into view (display appears at power on).

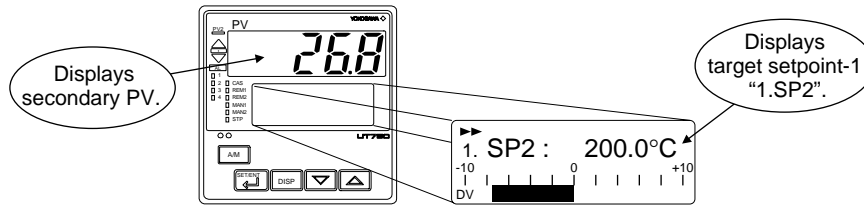

In steps 2 and later, illustrations of the LCD are cited to explain the procedure.

2. Press the key for **more than 3 seconds** to call up the main menu "MODE".

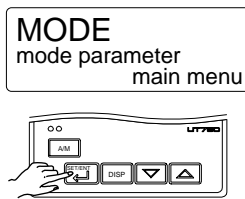

3. Press the key twice to display the main menu "LP2".

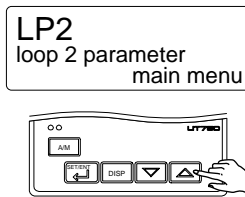

4. Press the key once to display the submenu "PAR".

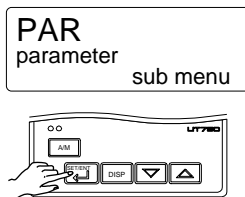

5. Press the key once to display the submenu "1.PID".

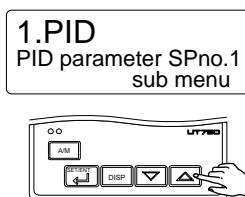

6. Press the key once to display the parameter "1.SP".

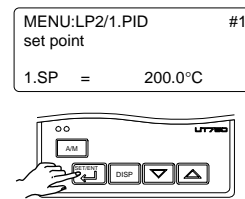

7. Press the or key to display the required setpoint.

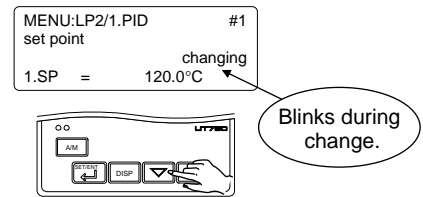

8. Press the key once to register the setpoint.

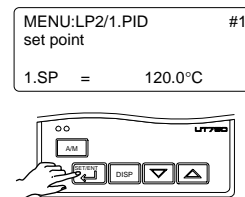

9. Press the key for **more than 3 seconds**. This returns you to the display shown at power-on (figure below).

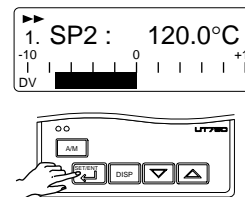

3.4 Performing/Canceling Auto-tuning of Secondary-loop

Auto-tuning should be carried out after setting a target setpoint (SP) of the secondary-loop. Make sure the controller is in automatic operation mode (AUTO) and in running state (RUN) before carrying out auto-tuning. See "3.11 Switching between Cascade (CAS), AUTO and MAN," to change to AUTO and "3.10 Switching between Run and Stop," to change to RUN.

NOTE

When on-off control is being used, auto-tuning cannot be carried out. Moreover, do not perform auto-tuning when controlling any of the following processes.

- Control processes with quick response such as flow control or pressure control
- Processes where even temporary output on/off results in inconvenience
- Processes where a large output change at control element results in inconvenience
- Processes where variations in PV may exceed an allowable range, adversely affecting product quality

1. Bring the operating display into view (display appears at power on).

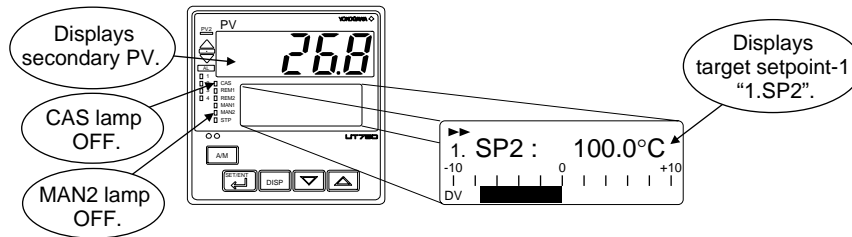

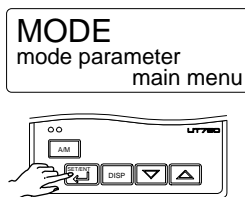

In steps 2 and later, illustrations of the LCD are cited to explain the procedure.

2. Press the  key for more than 3 seconds to call up the main menu "MODE".

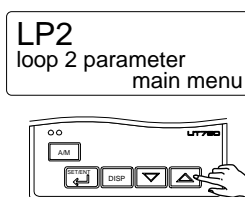

3. Press the  key twice to display the main menu "LP2".



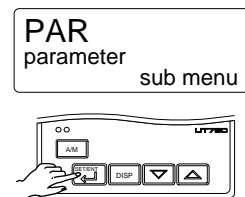

4. Press the  key once to display the submenu "PAR".



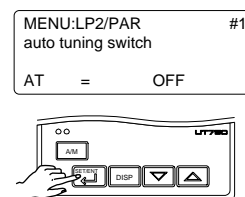

5. Press the  key once again to display the parameter "AT".

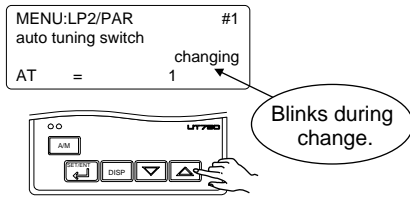

6. Press the  or  key to display the required setpoint. Tuning for 1.SP is AT = 1. To cancel auto-tuning, set AT = OFF.



7. Press the  key once to register the setpoint. (This starts auto-tuning.) If the  key is pressed when AT = OFF, auto-tuning will be cancelled. In this case, PID contains the value existing before auto-tuning.

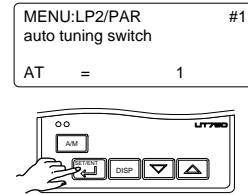

8. During auto-tuning, the panel indications become as shown below.

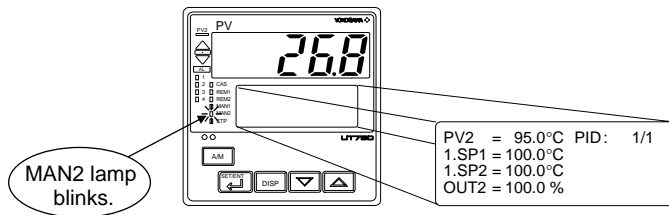

Auto-tuning is complete when the MAN2 lamp goes off.

3.5 Performing/Canceling Auto-tuning of Primary-loop

Auto-tuning should be carried out after setting a target setpoint (SP) of the primary-loop. Make sure the controller is in cascade operation mode (CAS) and in running state (RUN) before carrying out auto-tuning. See "3.11 Switching between Cascade (CAS), AUTO and MAN," to change to CAS and "3.10 Switching between Run and Stop," to change to RUN.

* To perform auto-tuning of the primary-loop, PID of the secondary-loop should be the appropriate value.

NOTE

When on-off control is being used, auto-tuning cannot be carried out. Moreover, do not perform auto-tuning when controlling any of the following processes.

- Control processes with quick response such as flow control or pressure control
- Processes where even temporary output on/off results in inconvenience
- Processes where a large output change at control element results in inconvenience
- Processes where variations in PV may exceed an allowable range, adversely affecting product quality

1. Bring the operating display into view (display appears at power on).

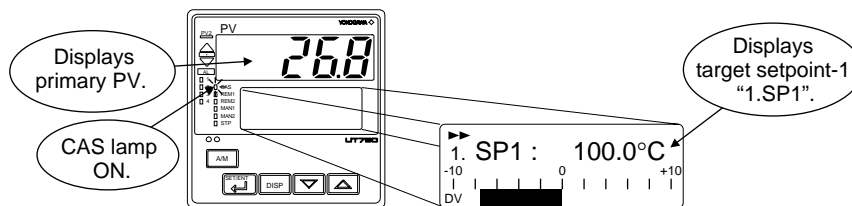

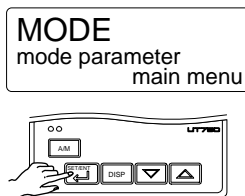

In steps 2 and later, illustrations of the LCD are cited to explain the procedure.

2. Press the key for more than 3 seconds to call up the main menu "MODE".

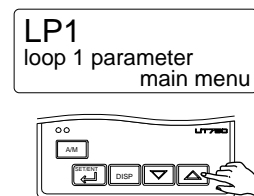

3. Press the key once to display the main menu "LP1".



- 4. Press the  key once to display the submenu "PAR".

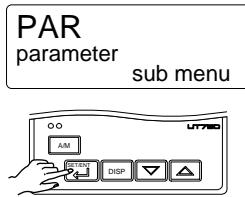

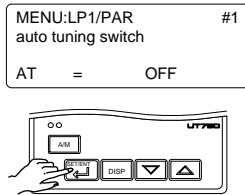

- 5. Press the  key once again to display the parameter "AT".

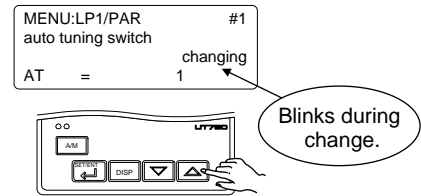

- 6. Press the  or  key to display the required setpoint. Tuning for 1.SP is AT = 1. To cancel auto-tuning, set AT = OFF.



- 7. Press the  key once to register the setpoint. (This starts auto-tuning.) If the  key is pressed when AT = OFF, auto-tuning will be cancelled. In this case, PID contains the value existing before auto-tuning.

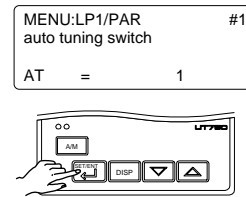

- 8. During auto-tuning, the panel indications become as shown below.

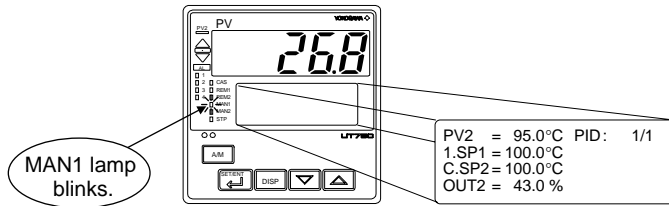

Auto-tuning is complete when the MAN1 lamp goes off.

3.6 Setting PID of Secondary-loop Manually

If you know the values to be set or if suitable PID constants cannot be obtained by auto-tuning, follow the procedure below to set values.

1. Bring the operating display into view (display appears at power on).

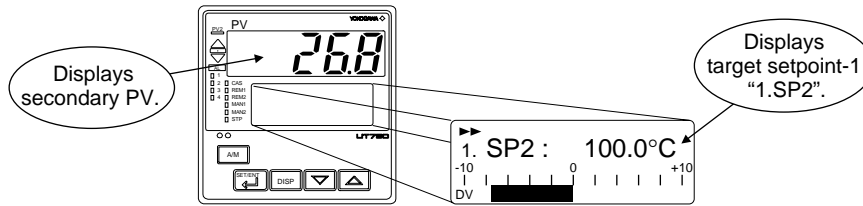

In steps 2 and later, illustrations of the LCD are cited to explain the procedure.

2. Press the key for more than 3 seconds to call up the main menu "MODE".

MODE
mode parameter
main menu

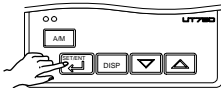

3. Press the key twice to display the main menu "LP2".

LP2
loop 2 parameter
main menu

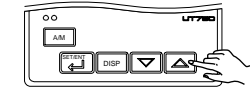

4. Press the key once to display the submenu "PAR".

PAR
parameter
sub menu

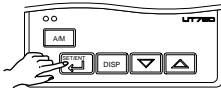

5. Press the key once to display the submenu "1.PID".

1.PID
PID parameter SPno.1
sub menu

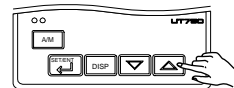

6. Press the key six times to display the parameter "1.P" (proportional band for 1.SP).

MENU:LP2/1.PID #6
proportional band
1.P = 5.0%

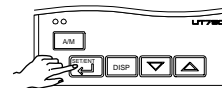

7. Press the or key to display the required setpoint.

MENU:LP2/1.PID #6
proportional band
1.P = 18.0%

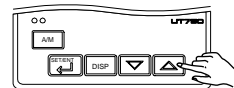

Blinks during change.

8. Press the  key once to register the setpoint.

```
MENU:LP2/1.PID          #6
proportional band
1.P = 18.0%
```

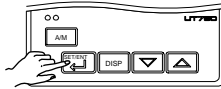

The same steps can be used for integral time (1.I) and derivative time (1.D) that are displayed after this.

[TIP]

For the PID parameter number you set in step 5, select:

- the submenu "1.PID" if the PID constants are for 1.SP;
- the submenu "2.PID" if the PID constants are for 2.SP;
- the submenu "3.PID" if the PID constants are for 3.SP; and
- the submenu "4.PID" if the PID constants are for 4.SP.

9. Press the  key for more than 3 seconds. This returns you to the display shown at power-on (figure below).

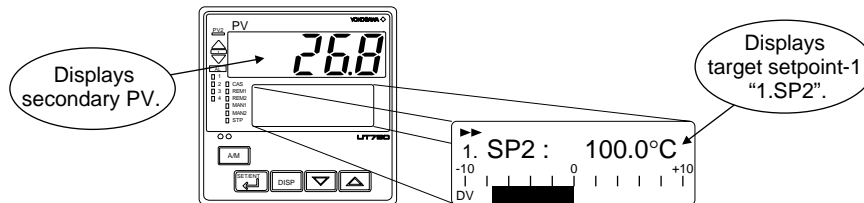

3.7 Setting PID of Primary-loop Manually

If you know the values to be set or if suitable PID constants cannot be obtained by auto-tuning, follow the procedure below to set values.

1. Bring the operating display into view (display appears at power on).

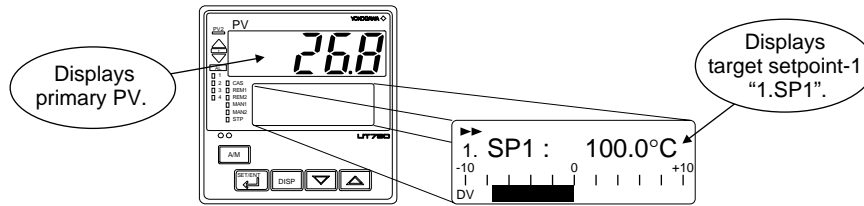

In steps 2 and later, illustrations of the LCD are cited to explain the procedure.

2. Press the key for more than 3 seconds to call up the main menu "MODE".

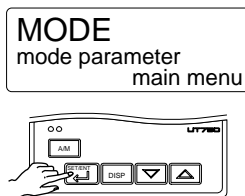

3. Press the key once to display the main menu "LP1".

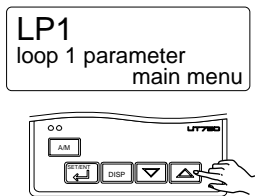

4. Press the key once to display the submenu "PAR".

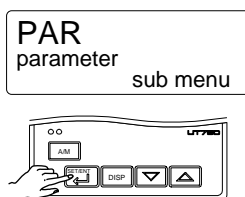

5. Press the key once to display the submenu "1.PID".

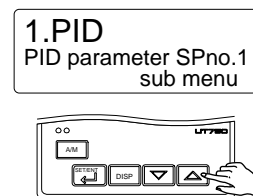

6. Press the key six times to display the parameter "1.P" (proportional band for 1.SP).

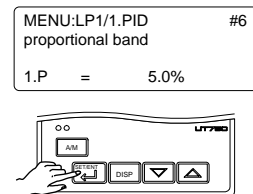

7. Press the or key to display the required setpoint.

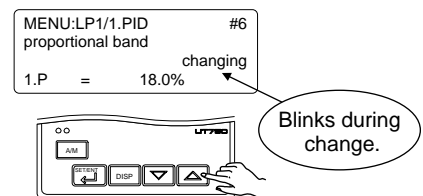

- 8. Press the  key once to register the setpoint.

MENU:LP1/1.PID #6
proportional band

1.P = 18.0%

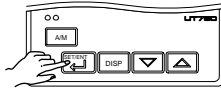

The same steps can be used for integral time (1.I) and derivative time (1.D) that are displayed after this.

[TIP]
For the PID parameter number you set in step 5, select:
the submenu "1.PID" if the PID constants are for 1.SP;
the submenu "2.PID" if the PID constants are for 2.SP;
the submenu "3.PID" if the PID constants are for 3.SP; and
the submenu "4.PID" if the PID constants are for 4.SP.

- 9. Press the  key for more than 3 seconds. This returns you to the display shown at power-on (figure below).

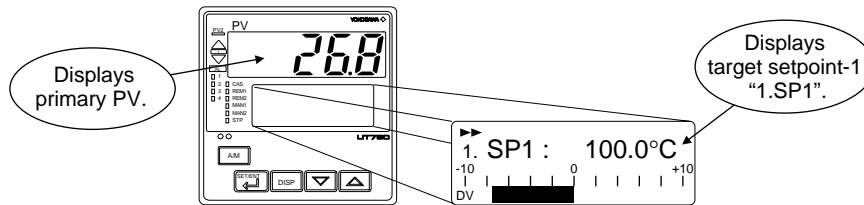

3.8 Setting Alarm Setpoints of Primary-loop

The following operating procedure describes an example of setting 160.0 to alarm-1 setpoint. Check alarm type before setting the alarm setpoint.

When changing the alarm type, see "2.7 Changing Alarm Type of Primary-loop."

Alarm output terminals	Factory-set defaults
Alarm-1 (terminal numbers ⑥-⑦)PV high limit alarm
Alarm-2 (terminal numbers ⑤-⑦)PV low limit alarm
Alarm-3 (terminal numbers ④-⑦)PV high limit alarm
Alarm-4 (terminal numbers ③-⑤)PV low limit alarm

- 1. Bring the operating display into view (display appears at power on).

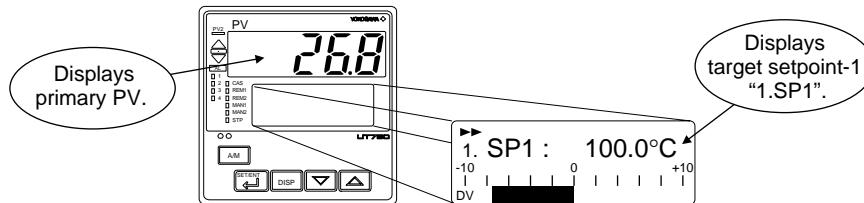

In steps 2 and later, illustrations of the LCD are cited to explain the procedure.

- 2. Press the  key for more than 3 seconds to call up the main menu "MODE".

MODE
mode parameter
main menu

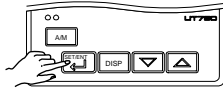

- 3. Press the  key once to display the main menu "LP1".

LP1
loop 1 parameter
main menu

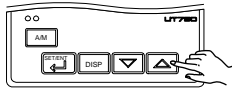

- 4. Press the  key once to display the submenu "PAR".

PAR
parameter
sub menu

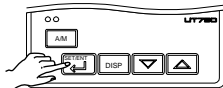

- 5. Press the  key once to display the submenu "1.PID".

1.PID
PID parameter SPno.1
sub menu

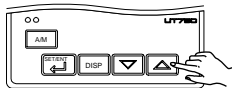

- 6. Press the  key twice to display the parameter "1.A1".

MENU:LP1/1.PID #2
alarm-1 set point
1.A1 = 200.0°C

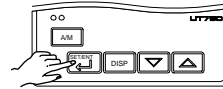

- 7. Press the  or  key to display the required setpoint.

MENU:LP1/1.PID #2
alarm-1 set point
1.A1 = 160.0°C

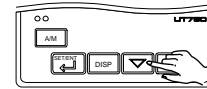

Blinks during change.

- 8. Press the  key once to register the setpoint.

MENU:LP1/1.PID #2
alarm-1 set point
1.A1 = 160.0°C

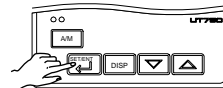

You can take the same steps for alarm-2 setpoint (1.A2), alarm-3 setpoint (1.A3), alarm-4 setpoint (1.A4) that are displayed after this.

- 9. Press the  key for more than 3 seconds. This returns you to the display shown at power-on (figure below).

1. SP1 : 100.0°C
-10 | 0 | +10
DV

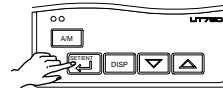

3.9 Selecting Target Setpoint Numbers (SPNO)

The following operating procedure describes an example of changing a target setpoint number (SPNO) from 1 to 2.

NOTE

- If a target setpoint number has been switched using contact input, when the contact input is on, that number cannot be selected by keystroke.
- The target setpoint numbers (SPNO) of the primary-loop and the secondary-loop are the same.

1. Bring the operating display into view (display appears at power on).

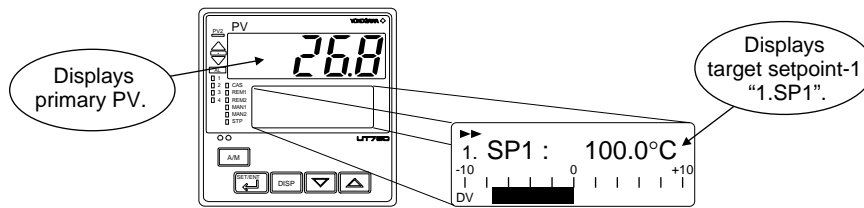

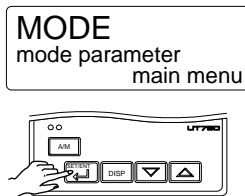

In steps 2 and later, illustrations of the LCD are cited to explain the procedure.

2. Press the  key for more than 3 seconds to call up the main menu "MODE".

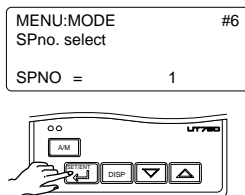

3. Press the  key several times to display the parameter "SPNO".



4. Press the  or  key to display the required setpoint.

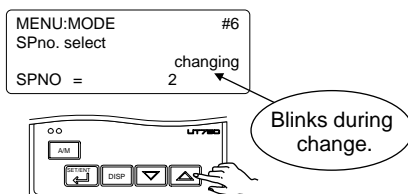

5. Press the  key once to register the setpoint.

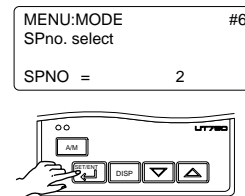

6. Press the  key for more than 3 seconds. This returns you to the display shown at power-on (figure below).

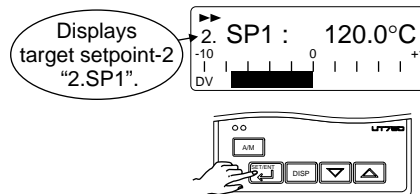

3.10 Switching between Run and Stop

Selection between the Run state (RUN) and Stop state (STOP) can be made with contact input 4 (DI4).

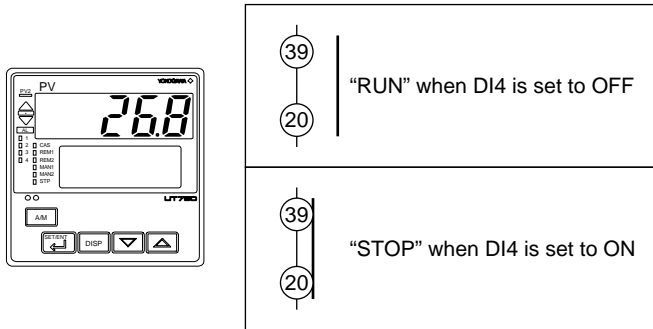

When at a stop, the controller behaves as described below:

PV input	Displays the PV value.
Control output	Provides the preset output value (factory-set to 0%).
Alarm output	Turns the output on in case of an alarm.

3.11 Switching between Cascade (CAS), AUTO and MAN

Switching between Cascade (CAS)/automatic (AUTO)/manual (MAN) is described below.

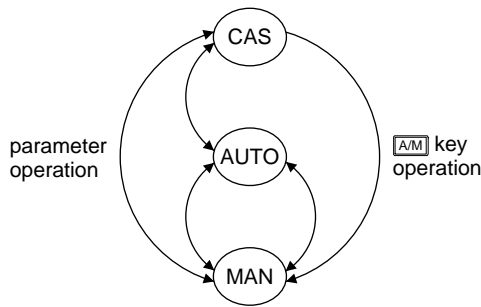

* AUTO and MAN operations are in the secondary-loop control only.

- **CAS → AUTO**
Manipulate the parameter
- **CAS → MAN**
Manipulate the key or the parameter
- **AUTO → CAS**
Manipulate the parameter
- **AUTO → MAN**
Manipulate the key or the parameter
- **MAN → CAS**
Manipulate the parameter
- **MAN → AUTO**
Manipulate the key or the parameter

■ Manipulating the parameter

1. Bring the operating display into view (display appears at power on).

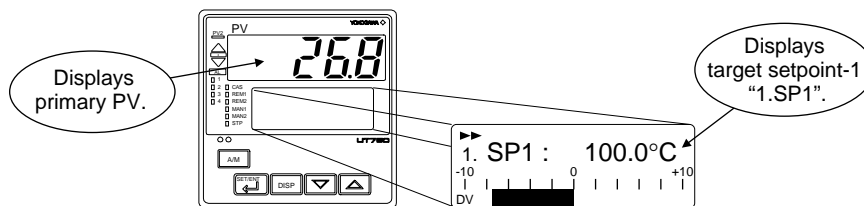

In steps 2 and later, illustrations of the LCD are cited to explain the procedure.

2. Press the key for more than 3 seconds to call up the main menu "MODE".

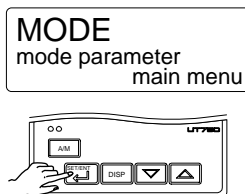

3. Press the key once to display the parameter "MODE".

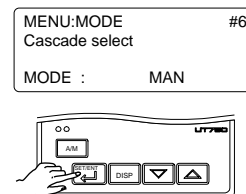

- 4. Press the or key to display the required setpoint.

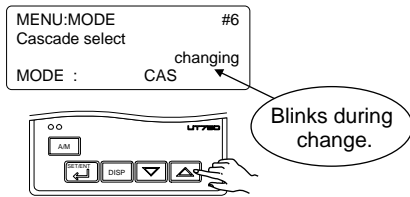

- 5. Press the key once to register the setpoint.

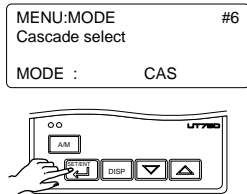

- 6. Automatically return to the display shown at power-on (figure below).

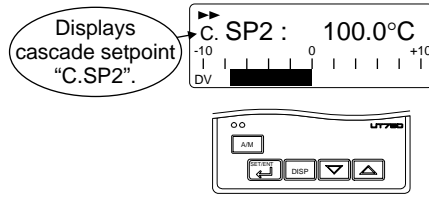

■ Manipulating the key

- 1. Bring the operating display into view (display appears at power-on).

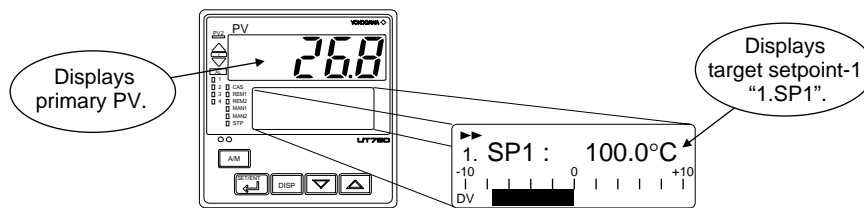

- 2. Each time you press the key on the front panel of the instrument, AUTO and MAN is switched alternately.

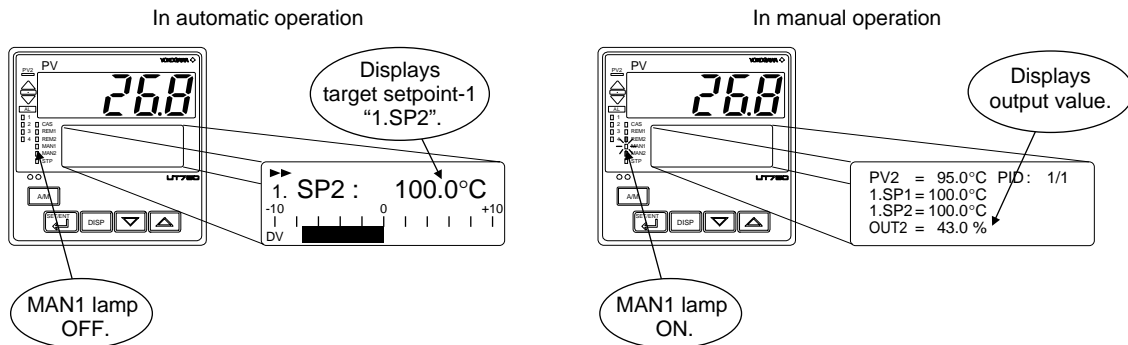



* Pressing the key during the cascade operation switches to the manual operation.

3.12 Manipulating Control Output during Manual Operation

NOTE

Control output cannot be changed if the controller is stopped. In this case, the preset output value (operating parameter PO) will be output.

A control output value is linked with a display value changed using the  or  key. Note that the control output changes as displayed without requiring the  key.

1. Bring manual operating display into view. For switching to manual operation, see “3.11 Switching between Cascade (CAS), AUTO and MAN”.

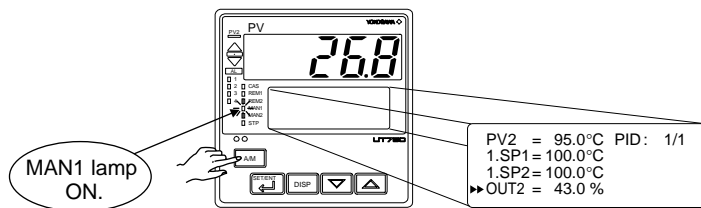

2. Press the  or  key to change a control output value. You don't need to press the  key.

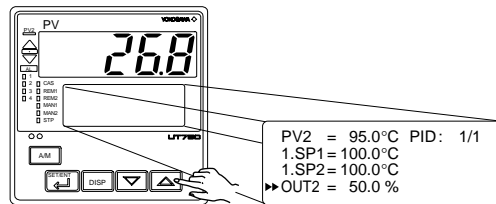



■ Manipulating the Control Output during Heating/Cooling Control

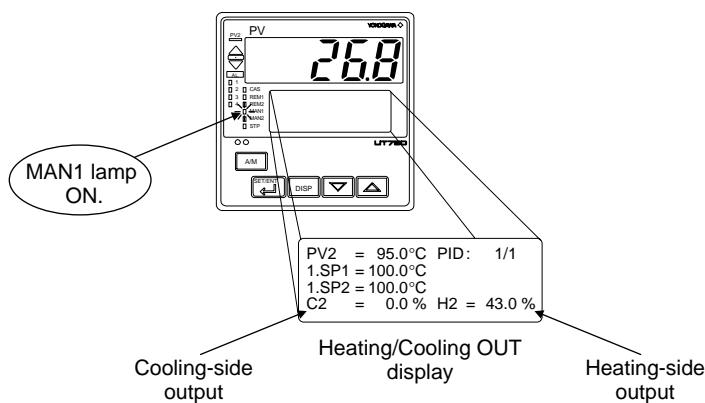

Showing the Heating/Cooling OUT display.



● Controller Behavior and Control Output Manipulation when the Dead Band is Positive

The following is an example when the DB parameter is set at 12.4%.

If you hold down the  key with the heating-side output under manipulation (i.e., cooling-side output C2 = 0.0%), the heating-side output (H2 =) decreases. Consequently, both the heating-side and cooling-side outputs change to 0.0%. If you keep the  key held down longer, you enter the state of manipulating the cooling-side output, and its value begins to increase.

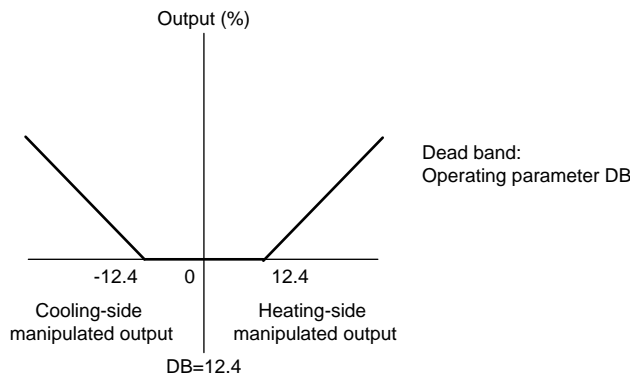

Inversely, if you hold down the  key with the cooling-side output under manipulation (i.e., heating-side output H2 = 0.0%), the cooling-side output (C2 =) decreases. Consequently, both the heating-side and cooling-side outputs go to 0.0%. If you keep the  key held down longer, you enter the state of manipulating the heating-side output, and its value begins to increase.



Change in manipulated output when the dead band is positive

● Controller Behavior and Control Output Manipulation when the Dead Band is Negative

The following is an example when the DB parameter is set at -12.4%.

If you hold down the  key with the heating-side output under manipulation (i.e., cooling-side output C2 = 0.0%), the heating-side output (H2 =) decreases. If the output H2 falls below 24.8%, the cooling-side output C2 begins to increase from 0.0%. If you keep the  key held down longer and the output C2 rises above 24.8%, the output H2 goes to 0.0% and you enter the state of manipulating the cooling-side output.

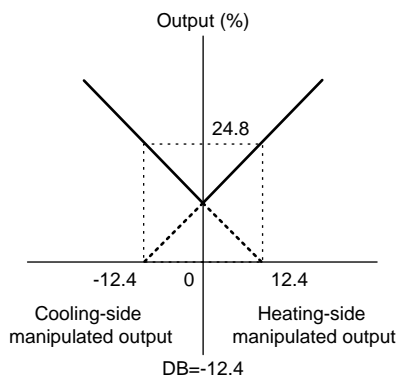

Change in manipulated output when the dead band is negative

4. Troubleshooting and Maintenance

4.1 Troubleshooting

■ Troubleshooting Flow

If the operating display does not appear after turning on the controller's power, follow the measures in the procedure below.

If a problem appears complicated, contact our sales representative.

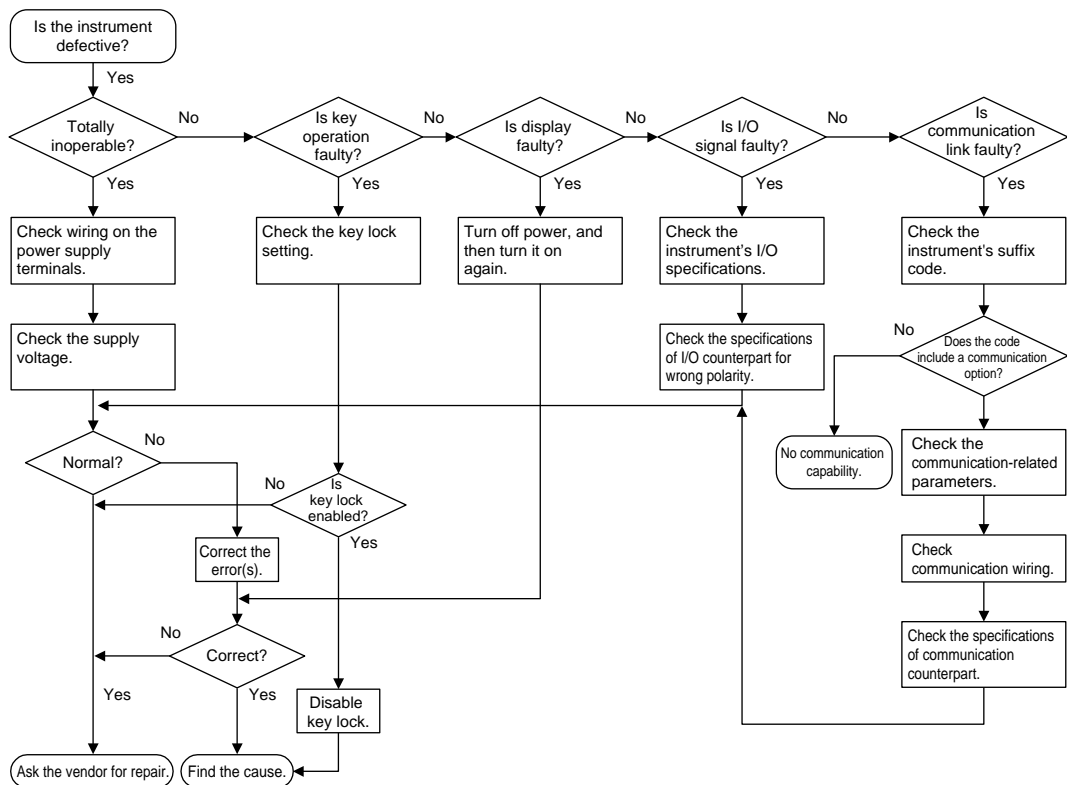

IMPORTANT

Take note of the parameter settings when asking the vendor for repair.

■ Errors at Power on

The following table shows errors that may be detected by the fault diagnosis function when the power is turned on.

Display position	Error indication	Description of error	PV	Control output	Alarm output	Retransmission output	Communication	Remedy
PV-indicating LED	E000	Faulty RAM	None	0% or less or OFF	OFF	0% or less	Stopped	Faulty Contact us for repair.
	E001	Faulty ROM			Undefined	Undefined		
	E002	System data error	Undefined	Undefined	Undefined			
	PV decimal point blinks.	Faulty calibration value	Normal action (out of accuracy)	Normal action (out of accuracy)	Normal action (out of accuracy)	Normal action (out of accuracy)		
								
LCD	Error code (See description below.)	Parameter error	Normal action	0% or less or OFF	Normal action	Normal action	Normal action	Check and set the initialized parameters.

An error code is displayed in the event of an error, according to its type.

An error code is a two-digit figure in which a combination of 6 bits of on and off is converted into a decimal number.

The following shows the relationship between each bit and parameter to be checked for abnormality.

Bit No.	6	5	4	3	2	1	0
Parameter to be checked	Operation mode/output	Operating parameters	Setup parameters	Range data	UT mode	Custom computing data	Calibration data

For example, if an error occurs with the operating parameter and calibration data, the error code will be as follows:

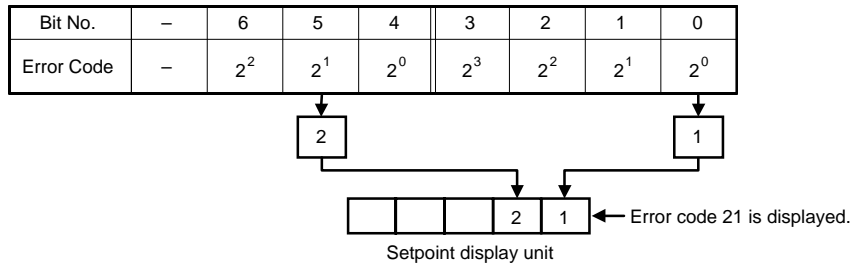

■ Possible Errors during Operation

The following shows possible errors occurring during operations.

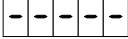
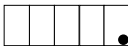
Display position (Note)	Error indication	Description of error	PV	Control output	Alarm output	Retransmission output	Communication	Remedy
3	Displays "RJC" and PV alternately	RJC error	Measured with RJC=0	Normal action	Normal action	Normal action	Normal action	Faulty Contact us for repair.
	E300	ADC error	105%	In AUTO: Preset value output In MAN: Normal action				Check wires and sensor.
	B.OUT	PV burnout error	Dependent on the BSL parameter Up-scale: 105% Down-scale: -5%	Normal action				Check process.
	OVER or -OVER	Excessive PV Out of -5 to 105%	-5% or 105%	Normal action				Check process. Press any key to erase error indication.
	E200	Auto-tuning failure (Time-out)		Action with PID existing before auto-tuning				Check process. Press any key to erase error indication.
2	Setpoint display 	Feedback resistor breakdown	Normal action	Stopped	Stopped	Normal action	Check the feedback resistor.	
	Left end of SP display unit blinks.	Faulty communication line		Normal action			Check wires and communication parameters, and make resetting. Recovery at normal receipt	
1	Decimal point at right end lights. 	Runaway (due to defective power or noise)	Undefined	0% or less or OFF	OFF	0% or less	Stopped	Faulty if power off/on does not reset start the unit. Contact us for repair.
-	All indications off	Power off	None					Check for abnormal power.

Note 1: PV-indicating LED display
 2: LCD
 3: Display showing the PV of the loop in which the error has been caused

■ Remedies if Power Failure Occurs during Operations

The operation status and remedies after a power failure differ with the length of power failure time:

● Instantaneous Power Failure of 20 ms or less

A power failure is not detected. Normal operation continues.

● Power Failure of about 2 seconds or less

The following show effects caused in "settings" and "operation status."

Alarm action	Continues. Alarm with standby function will enter standby status.
Setting parameter	Set contents of each parameter are retained.
Auto-tuning	Cancelled.
Control action	Action before power failure continues.

● **Power Failure of more than about 2 seconds**

The following show effects caused in “settings” and “operation status.”

Alarm action	Continues. Alarm with standby function will enter standby status.	
Setting parameter	Set contents of each parameter are retained.	
Auto-tuning	Cancelled.	
Control action	Differs with setting of setup parameter “R.MD”(restart mode).	
	R.MD setting	Control action after recovery from power failure
	CONT	Continues action before power failure. (Factory-set default)
	MAN	Outputs preset output value (PO) as control output and continues action set before power failure in MAN mode. For heating/cooling control, starts action from heating-side output value and cooling-side output value of 50% of control computation output.
AUTO	Outputs preset output value (PO) as control output and continues action set before power failure in AUTO mode. For heating/cooling control, starts action from heating-side output value and cooling-side output value of 50% of control computation output.	

■ Troubleshooting when the Controller Fails to Operate Correctly

If your control tasks are not successful, check the preset parameters and controller wiring before concluding the controller to be defective. The following show some examples of troubleshooting you should refer to in order to avoid the possibility of other problems.

● The Controller does not Show the Correct Process Variable (PV).

- The UT750 controllers have a universal input.
The type of PV input can be set/changed using the parameter "IN1". At this point, the controller must be wired correctly according to the selected type of PV input. Check the wiring first if the controller fails to show the correct PV value. To do this, refer to "2. Initial Settings."
With the parameters "RH1", "RL1", "SDP1", "SH1" and "SL1", it is possible to scale the input signal and change its number of decimal places. Also check that these parameters are configured correctly.

● The Controller does not Provide any Control Output or the Control Output does not Change at all.

- The UT750 controllers have a universal output.
The type of control output can be set/changed using the parameter "OT2".
At this point, the controller must be wired correctly according to the selected type of control output. Check the wiring first if the controller provides no control output. To do this, refer to "1.5 Terminal Wiring Diagrams."
With the parameters "OH" and "OL", it is possible to set/change the high and low limits of control output. The control output may not change at all, however, because of restrictions on these parameters. Also check the restrictions on these parameters.
- The control output can only be changed when the controller is in the MAN mode.
If the MAN1 lamp is off (i.e., the controller is in the AUTO mode), you cannot change the control output using key operation.

● The Control Output does not Change soon after the Target Setpoint SP has been Changed.

- If this happens, check the setpoint of the parameter "MOD". In cases where fixed-point control is selected as the PID control mode (MOD = 1), tracking based on the I-term works to prevent the control output from changing suddenly even if the target setpoint SP is varied.
The control output therefore may appear to be working incorrectly at first; however it gradually adapts itself to the new target setpoint.

4.2 Maintenance

This section describes the cleaning and maintenance of the UT750.

4.2.1 Cleaning

The front panel and operation keys should be gently wiped with a dry cloth.



NOTE

Do not use alcohol, benzine, or any other solvents.

4.2.2 Replacing Brackets

When the brackets are broken or lost, purchase the following brackets for replacement.

Target Model	Part No.	Sales Unit
UT750	T9115NL	A large bracket and small bracket in pair

SEE ALSO

“1.2 How to Install,” for how to replace brackets.

4.2.3 Attaching Terminal Cover

When a terminal cover is necessary, purchase the following part.

Target Model	Part No.	Sales Unit
UT750	T9115YD	1

■ Attaching Terminal Cover

The procedure for attaching the terminal cover is as follows.



Do not touch the terminals on the rear panel when power is being supplied to the controller. Doing so may result in electric shock.

Before attaching the terminal cover, turn off the source circuit breaker and use a tester to check that the power cable is not conducting any electricity.

1. Before attaching the terminal cover, fold it once or twice so that the side which has the "Handle With Care" symbol () is on the outside.

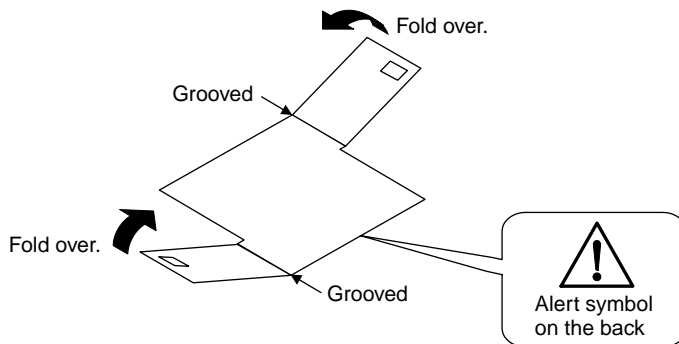

Folding Direction of Terminal Cover



Do not fold the terminal cover the wrong way, doing so not only reduces the cover's strength but may also cause the hinge to crack, thereby disabling attachment.

2. With the cover properly folded, fit its top and bottom holes to the protrusions of the mounting brackets.

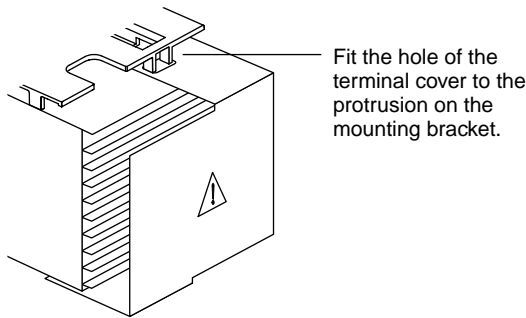

Attaching Terminal Cover

4.2.4 Replacing Parts with a Limited Service Life

The following UT750 parts have a limited service life. The service life given in the table assume that the controller is used under normal operating conditions.

Part	Service life
Aluminum electrolytic condenser	About 10 years (rated)
Batteries for backup	About 10 years (rated)
Alarm output relays	About 100,000 more ON-OFF operations or with resistance load
Control output relays	About 100,000 more ON-OFF operations or with resistance load

If any of these parts, except control output relays, cause a controller failure due to deterioration, contact your dealer for replacement at your cost.

SEE ALSO

“4.2.5 Replacing Control Output Relays,” for how to replace the control output relays.

4.2.5 Replacing Control Output Relays

This subsection describes how to replace the control output relays.

Since inspection is needed in case parts are replacement will be carried out by a YOKOGAWA engineer or an engineer certified by YOKOGAWA. When replacement is required, contact your nearest YOKOGAWA dealer.



Always turn off the power before starting the work in order to avoid electric shock.

Do not pull out the internal unit for any other purpose other than to replace the control output relays.

1. Insert a flat-blade screwdriver (tip width of 6 mm is recommended) into the opening (4 openings are on the top and bottom of bezel) with the tip in parallel with the front panel, and then turn the screwdriver gently. Take this procedure to four openings 1, 2, 3 and 4 (see the figure below) on the upper and lower parts of the bezel, in order. The bezel slightly moves forward from the housing.

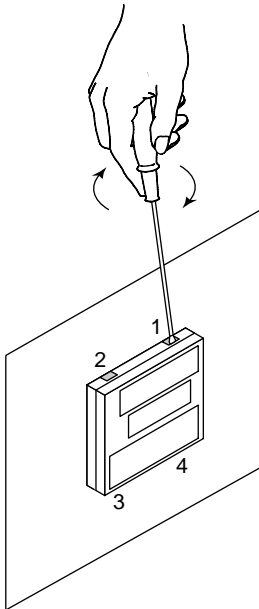

2. Push up the center of the bottom gasket of bezel by a finger to release the latch.

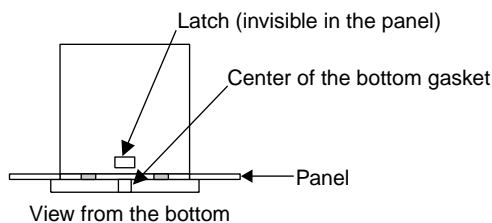

3. Insert the screwdriver into the openings and flip the tip forward to move the bezel more forward.

- 4. Hold the bezel and pull it along with the internal unit out of the housing.
(Note) Be careful not to damage the RJC sensor.

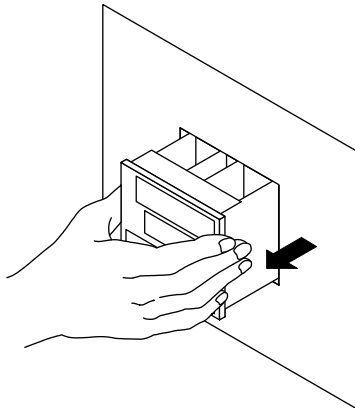

- 5. The location and number of the relays differ depending on the model code of the UT750. Confirm the location of the control output relay to be replaced before pulling out the relay.

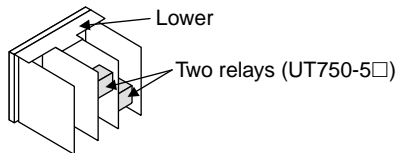

- 6. Pull out the relay to be replaced.
The control output relays are easy to remove and mount, since they are connected via a socket onto the print boards.

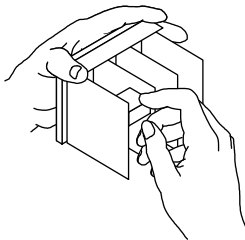

Insert the new relay in the socket. Use the following relay.

Manufacturer	OMRON
Model	G6B-2114P-FD-US-P6B
Power supply	12 V DC

- 7. Insert the internal unit into the housing.**
Apply power to the controller and confirm that the initial operating display is shown. If the operating display is not shown properly, turn off the controller and pull out the internal unit. Then, insert it into the housing again.

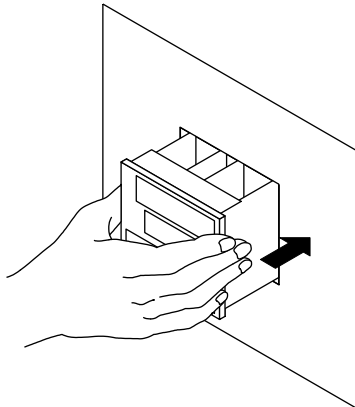

This completes replacement of the control output relay.

Blank Page

5. Parameters

5.1 Parameter Map

This section contains “Operating Parameter Map” and “Setup Parameter Map” for UT750 as a guideline for setting parameters.





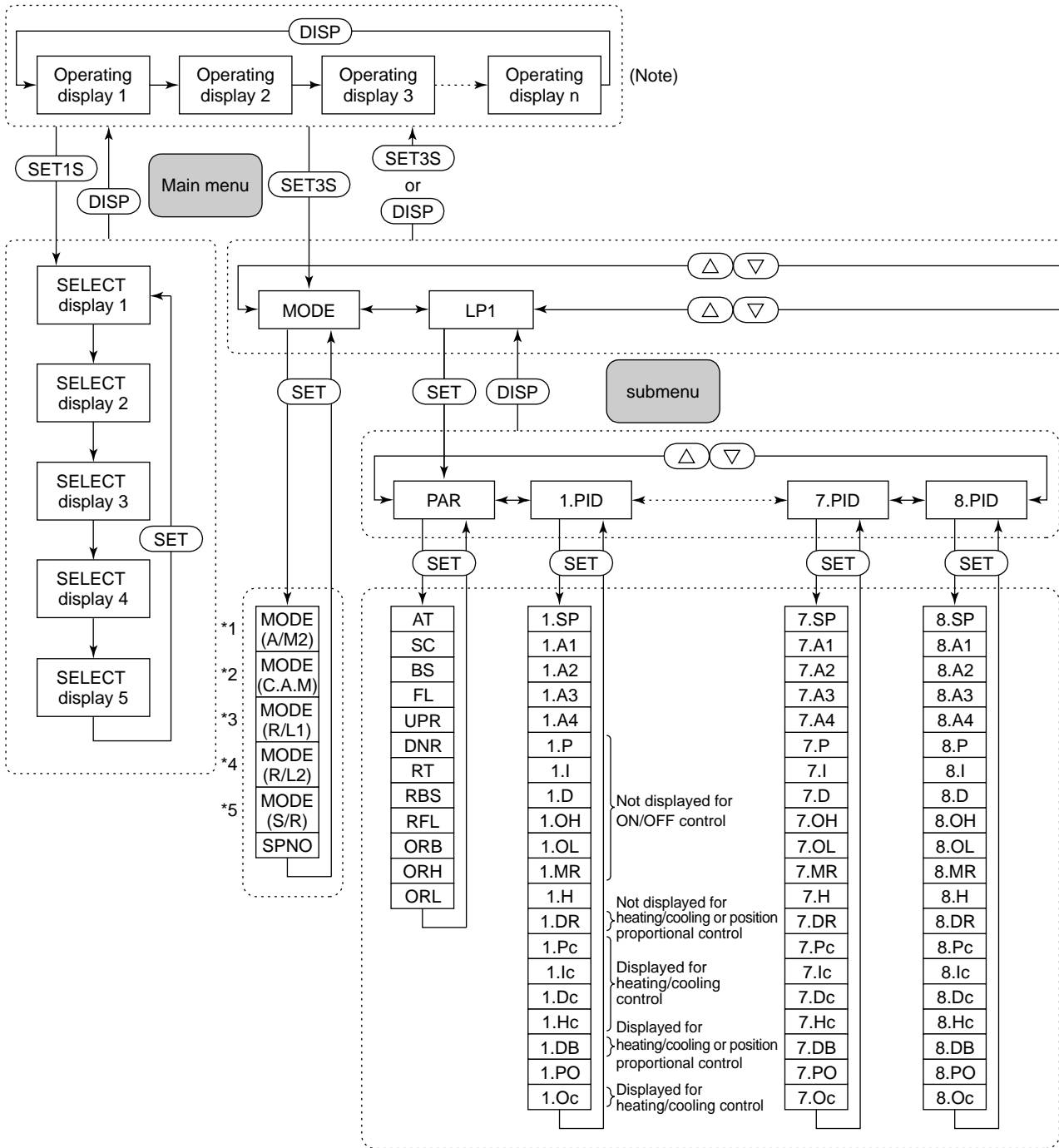

These maps are helpful in finding the positions of the displays when setting the parameters, and should be used as a quick reference for the entire range of parameter displays.

UT750 Operating Parameter Map

Operating Display



- *1 Parameter MODE (A/M2) is displayed when UT mode is "Dual-loop control" or "Temperature and humidity control."
- *2 Parameter MODE (C.A.M) is displayed when UT mode is "Cascade secondary-loop control" or "Cascade control."
- *3 Parameter MODE (R/L1) is displayed only for the controller with auxiliary analog (remote) input.
- *4 Parameter MODE (R/L2) is displayed only for the dual-loop type controller with auxiliary analog (remote) input.
- *5 Parameter MODE (S/R) is displayed when the contact input registration parameter S/R (setup parameter) is set to "0."
- *6 Main menu LP2 is displayed when UT mode is "Cascade control," "Dual-loop control," "Temperature and humidity control" or "Cascade control with two universal inputs."

(SET) : Press the  key once.
 (DISP) : Press the  key once.
 (SET1S) : Press the  key for 1 second.
 (SET3S) : Press the  key for 3 seconds.
 (Δ) (▽) : Press the  or  key once.

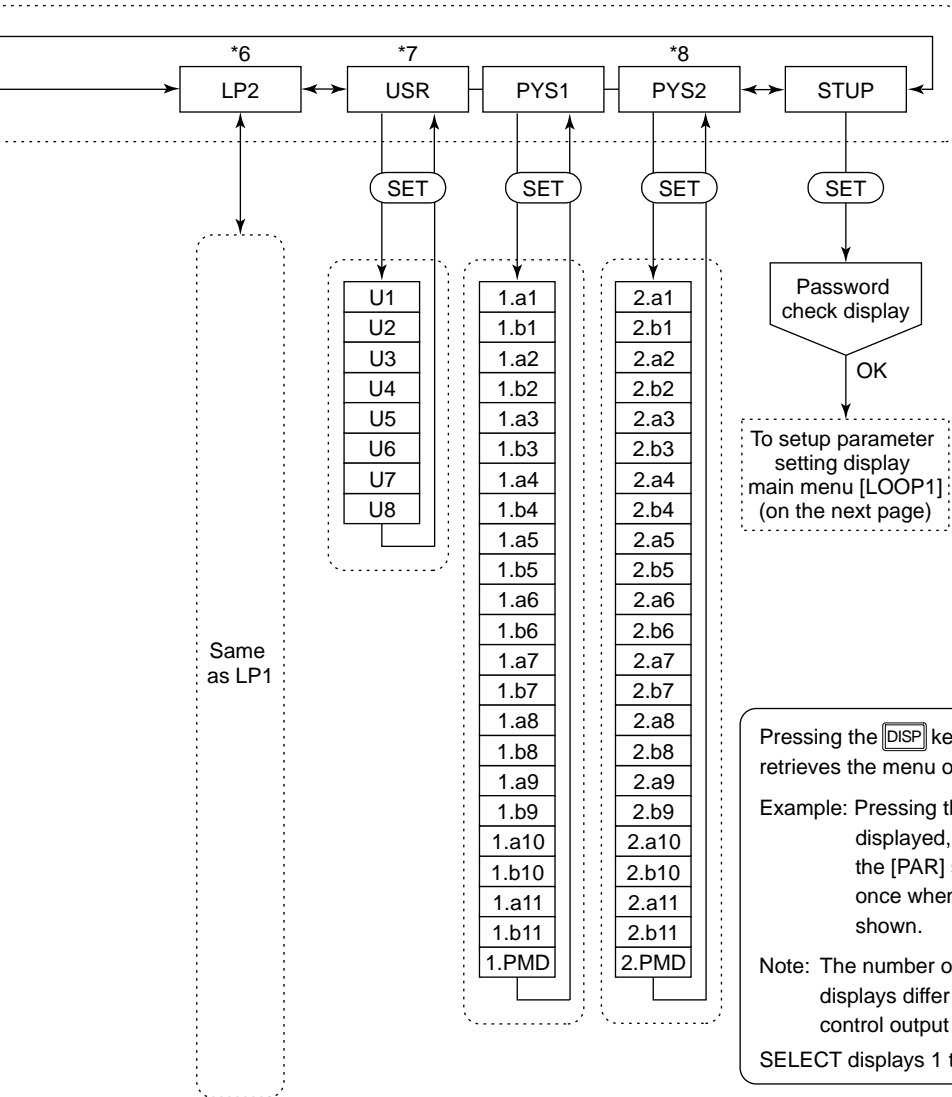

Pressing the **(DISP)** key once when a parameter setting display is shown retrieves the menu of that parameter setting display.

Example: Pressing the **(DISP)** key once when the [PAR] submenu is displayed, will display the [LP1] main menu. Conversely, the [PAR] submenu will reappear by pressing the **(DISP)** key once when the [PAR] submenu's "FL" parameter display is shown.

Note: The number of operating displays and the contents of such displays differ according to the UT750 models, UT modes and control output types.



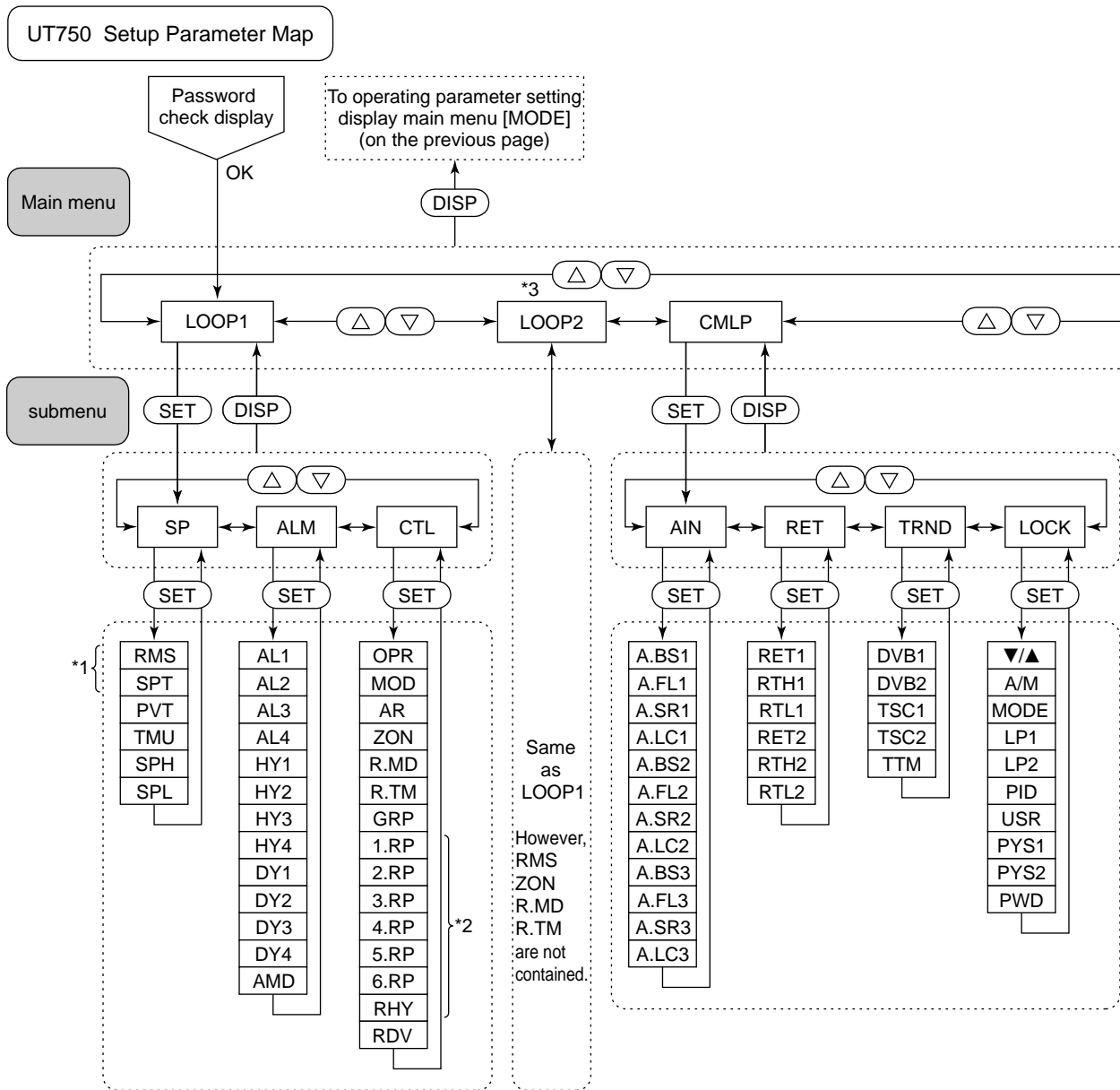

SELECT displays 1 to 5 are shown only when they are registered.

- *7 Main menu USR is displayed when UT mode is "Loop control with PV switching," "Loop control with PV auto-selector," "Loop control with PV switching and two universal inputs," or "Loop control with PV auto-selector and two universal inputs."
- *8 Main menu PYS2 is displayed when UT mode is "Cascade control," "Loop control with PV switching," "Dual-loop control," "Temperature and humidity control," "Cascade control with two universal inputs" or "Loop control with PV switching and two universal inputs."



Pressing the **DISP** key once when a parameter setting display is shown retrieves the submenu of that parameter setting display.

- *1 Parameters RMS and SPT are displayed only for the controller with auxiliary analog (remote) input.
- *2 Displayed when parameter ZON is "1."
- *3 Main menu LOOP2 is displayed when UT mode is "Cascade control," "Dual-loop control," "Temperature and humidity control," or "Cascade control with two universal inputs."

(SET) : Press the  key once.
 (DISP) : Press the  key once.
 (Δ) (▽) : Press the  or  key once.

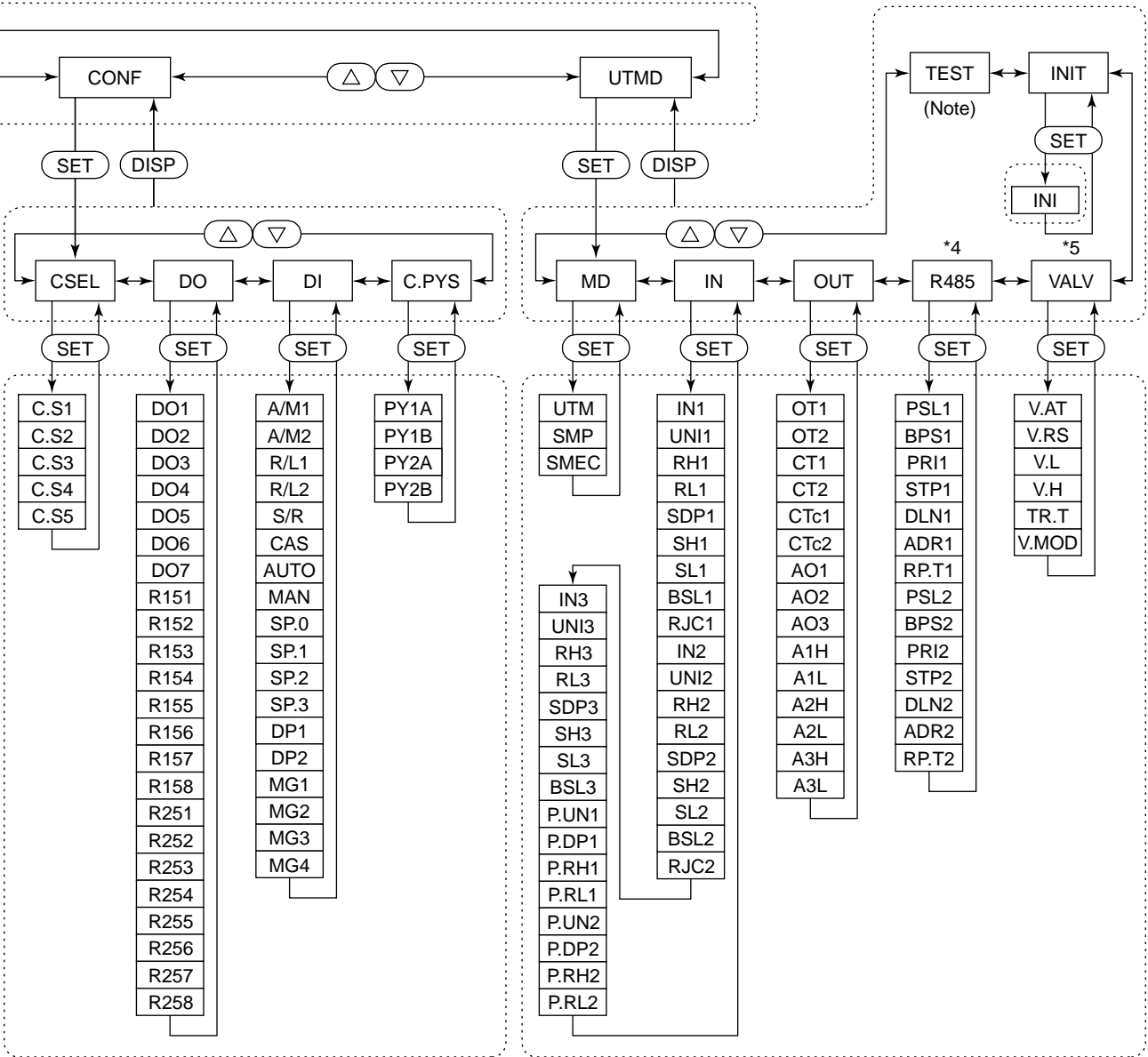

Note: The parameter items shown on the [TEST] submenu of the setup parameter setting display are to be used by Yokogawa service personnel to check the controller functions. User cannot set or change these parameters.

*4 Submenu R485 is displayed only for the controller with communication function.

*5 Submenu VALV is displayed only for the position proportional controller.

5.2 Lists of Parameters

This section describes the functions of parameters briefly. In addition, each parameter table has a "User Setting" column, where you can record your setpoints when setting them in the controller.

- * Parameters relating to PV or setpoints should all be set in real numbers. For example, use temperature values to define target setpoints and alarm setpoints for temperature input.
- * The "User Setting" column in the table is provided for the customer to record setpoints.
- * Numbers in () are the parameter setpoints that apply when the communication function is used. ex. AUTO (0), MAN (1), CAS (2).

■ Operating Parameters

● Operation Mode Parameters

Located in: Main menu = **MODE**

Parameter Symbol	Name of Parameter	Setting Range and Description	Initial Value	User Setting
MODE (C.A.M)	Cascade/Auto/Man switching	AUTO (0): automatic MAN (1): manual CAS (2): cascade		
MODE (R/L1)	Remote/Local switching	Set to "Local" when carrying out control using the target setpoints of the controller or to "Remote" when using target setpoints acquired via a remote input signal or communication. Use the setup parameter RMS, "Remote Input Selection," to determine whether the target setpoints should be acquired via the remote input signal or communication. REMOTE (1): Remote mode LOCAL (0): Local mode	LOCAL (0)	
MODE (S/R)	Run/Stop switching	Outputs the predetermined (preset) fixed value when the controller stops. A preset output value can be defined for each target setpoint using the operating parameter "PO". STOP (1): Stops operation. RUN (0): Starts operation.	RUN (0)	
SPNO	Target setpoint number selection	1: Selects target setpoint-1 (1.SP). 2: Selects target setpoint-2 (2.SP). 3: Selects target setpoint-3 (3.SP). 4: Selects target setpoint-4 (4.SP). Likewise, options 5 to 8 select target setpoints 5 (5.SP) to 8 (8.SP).	1	

The following parameter is for cascade primary-loop.

● **Operation-related Parameters (Primary)**

Located in: Main menu = **LP1** ; Submenu = **PAR**

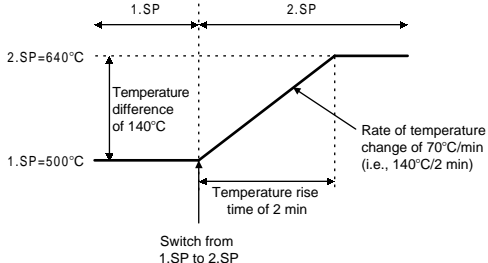
Parameter Symbol	Name of Parameter	Setting Range and Description	Initial Value	User Setting
AT	Auto-tuning	OFF (0): No auto-tuning 1: Auto-tuning for 1.SP 2: Auto-tuning for 2.SP 3: Auto-tuning for 3.SP 4: Auto-tuning for 4.SP 5 to 8: Perform auto-tuning on a group basis in the same way as 1 to 4 9: Performs auto-tuning to all groups 1 to 8.	OFF (0)	
SC	"SUPER" function	OFF (0): Disable 1: Overshoot suppressing function Suppresses overshoots generated by abrupt changes in the target setpoint or by disturbances. 2: Hunting suppressing function (Stable mode) Suitable to stabilize the state of control when the load varies greatly, or the target setpoint is changed. Enables to answer the wider characteristic changes compared with Response mode. 3: Hunting suppressing function (Response mode) Enables quick follow-up and short converging time of PV for the changed target setpoint. Note: Use "SUPER" function (SC) 2 or 3 in PID control or PI control. "SUPER" function 2 or 3 is not available in the following controls: 1) ON/OFF control 2) P control (control for proportional band only) 3) PD control (control for proportional band and derivative item only) 4) Heating/cooling control Can not be used for the control processes with quick response such as flow control or pressure control.	OFF (0)	
BS	PV input bias	-100.0% to 100.0% of primary PV input range span Used to correct the PV input value.	0.0% of primary PV input range span	
FL	PV input filter	OFF (0), 1 to 120 sec. Used when the PV input value fluctuates.	OFF (0)	
UPR	Setpoint ramp-up-rate	OFF (0) 0.0% + 1 digit of primary PV input range span to 100.0% of primary PV input range span	OFF (0)	
DNR	Setpoint ramp-down-rate	Set ramp-up-rate or ramp-down-rate per hour or minute. Sets unit in ramp-rate-time unit (TMU). Used to prevent the target setpoint from changing suddenly. The ramp setting function works when: 1. the target setpoint is changed (e.g., "1.SP" is changed from 100°C to 150°C); 2. the target setpoint number (SPNO) is changed (e.g., the parameter is changed from 1.SP to 2.SP); 3. the power is turned on or has recovered from a failure; or 4. the operating mode is changed from Manual to Auto. 	OFF (0)	
RT	Ratio setting	0.001 to 9.999 Target setpoint = Remote input × Ratio setpoint + Remote bias	1.000	
RBS	Remote input bias	-100.0 to 100.0% of primary PV input range span Used to correct the remote input value.	0.0% of primary PV input range span	
RFL	Remote input filter	OFF (0), 1 to 120 sec. Used when the remote input value fluctuates.	OFF (0)	
ORB	ON/OFF rate detection band	0.0 to 100.0% of primary PV input range span	1.0% of primary PV input range span	
ORH	ON/OFF rate high limit	ORL + 1 digit to 105.0%	100.0%	
ORL	ON/OFF rate low limit	-5.0% to ORH - 1 digit	0.0%	

The following parameter is for cascade primary-loop.

● **Setpoint-, Alarm- and PID-related Parameters (Primary)**

Located in: Main menu = **LP1** ; Submenu = **1.PID**

The table below lists the Target Setpoint-1 (1.SP) operating parameter and parameters that apply to the 1.SP parameter.

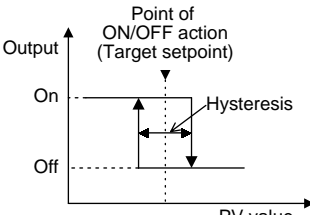
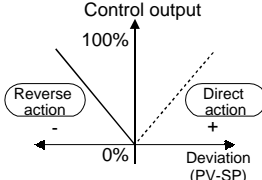
Parameter Symbol	Name of Parameter	Setting Range and Description	Initial Value	User Setting
1.SP	Target setpoint-1	0.0 to 100.0% of primary PV input range However, between target setpoint limiter lower limit (SPL) and upper limit (SPH)	0.0% of primary PV input range	
1.A1	Alarm-1 setpoint	PV alarm / SP alarm: -100.0 to 100.0% of primary PV input range Deviation alarm: -100.0 to 100.0% of primary PV input range span Output alarm: -5.0 to 105.0% Timer alarm (for alarm-1 only): 0.00 to 99.59 (hour, min.) or (min., sec.) Allows alarms 1 to 4 (1.A1 to 1.A4) to be set for target setpoint 1 (1.SP). Four alarms can also be set for target setpoints 2 to 8.	PV high limit/SP high limit alarm: 100.0% of primary PV input range Deviation alarm: 0.0% of primary PV input range span Other PV/SP low limit alarm: 0.0% of primary PV input range Output high limit alarm: 100.0% Output low limit alarm: 0.0%	
1.A2	Alarm-2 setpoint			
1.A3	Alarm-3 setpoint			
1.A4	Alarm-4 setpoint			
1.P	Proportional band	0.1 to 999.9% of primary PV input range	5.0%	
1.I	Integral time	OFF (0), 1 to 6000 sec.	240 sec.	
1.D	Derivative time	OFF (0), 1 to 6000 sec.	60 sec.	
1.OH	Output high limit	-5.0 to 105.0% (1.OL < 1.OH)	100%	
1.OL	Output low limit	-5.0 to 105.0% (1.OL < 1.OH) SD (shutdown): Set in manual operation in 4-20 mA control output. Output is 0 mA.	0.0%	
1.MR	Manual reset	-5.0 to 105.0% (enabled when integral time "1.I" is OFF) The manual reset value equals the output value when PV = SP is true. For example, if the manual reset value is 50%, the output value is 50% when PV = SP becomes true.	50.0%	
1.H	ON/OFF control hysteresis	In ON/OFF control: 0.0 to 100.0% of primary PV input range span Hysteresis can be set in the target setpoint when the controller is performing ON/OFF control. 	ON/OFF control: 0.5% of primary PV input range span	
1.DR	Direct/reverse action switching	REVERSE (0): reverse action, DIRECT (1): direct action 	REVERSE (0)	
1.PO	Preset output	-5.0 to 105.0% In Stop mode, fixed control output can be generated.	0.0%	

If you are using two or more groups of setpoint, alarm and PID parameters, use the following table to record their values.

Parameter	n=2	n=3	n=4	n=5	n=6	n=7	n=8
n.SP							
n.A1							
n.A2							
n.A3							
n.A4							
n.P							
n.I							
n.D							
n.OH							
n.OL							
n.MR							
n.H							
n.DR							
n.PO							

The following parameter is for cascade secondary-loop.

● **Operation-related Parameters (Secondary)**

Located in: Main menu = **LP2** ; Submenu = **PAR**

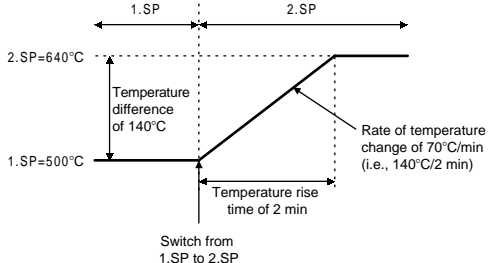
Parameter Symbol	Name of Parameter	Setting Range and Description	Initial Value	User Setting
AT	Auto-tuning	OFF (0): No auto-tuning 1: Auto-tuning for 1.SP 2: Auto-tuning for 2.SP 3: Auto-tuning for 3.SP 4: Auto-tuning for 4.SP 5 to 8: Perform auto-tuning on a group basis in the same way as 1 to 4 9: Performs auto-tuning to all groups 1 to 8.	OFF (0)	
SC	"SUPER" function	OFF (0): Disable 1: Overshoot suppressing function Suppresses overshoots generated by abrupt changes in the target setpoint or by disturbances. 2: Hunting suppressing function (Stable mode) Suitable to stabilize the state of control when the load varies greatly, or the target setpoint is changed. Enables to answer the wider characteristic changes compared with Response mode. 3: Hunting suppressing function (Response mode) Enables quick follow-up and short converging time of PV for the changed target setpoint. Note: Use "SUPER" function (SC) 2 or 3 in PID control or PI control. "SUPER" function 2 or 3 is not available in the following controls: 1) ON/OFF control 2) P control (control for proportional band only) 3) PD control (control for proportional band and derivative item only) 4) Heating/cooling control Can not be used for the control processes with quick response such as flow control or pressure control.	OFF (0)	
BS	PV input bias	-100.0% to 100.0% of secondary PV input range span Used to correct the PV input value.	0.0% of secondary PV input range span	
FL	PV input filter	OFF (0), 1 to 120 sec. Used when the PV input value fluctuates.	OFF (0)	
UPR	Setpoint ramp-up-rate	OFF (0) 0.0% + 1 digit of secondary PV input range span to 100.0% of secondary PV input range span	OFF (0)	
DNR	Setpoint ramp-down-rate	Set ramp-up-rate or ramp-down-rate per hour or minute. Sets unit in ramp-rate-time unit (TMU). Used to prevent the target setpoint from changing suddenly. The ramp setting function works when: 1. the target setpoint is changed (e.g., "1.SP" is changed from 100°C to 150°C); 2. the target setpoint number (SPNO) is changed (e.g., the parameter is changed from 1.SP to 2.SP); 3. the power is turned on or has recovered from a failure; or 4. the operating mode is changed from Manual to Auto. 	OFF (0)	
RT	Ratio setting	0.001 to 9.999 Target setpoint = Remote input × Ratio setpoint + Remote bias	1.000	
RBS	Remote input bias	-100.0 to 100.0% of secondary PV input range span Used to correct the remote input value.	0.0% of secondary PV input range span	
RFL	Remote input filter	OFF (0), 1 to 120 sec. Used when the remote input value fluctuates.	OFF (0)	
ORB	ON/OFF rate detection band	0.0 to 100.0% of secondary PV input range span	1.0% of secondary PV input range span	
ORH	ON/OFF rate high limit	ORL + 1 digit to 105.0%	100.0%	
ORL	ON/OFF rate low limit	-5.0% to ORH - 1 digit	0.0%	

The following parameter is for cascade secondary-loop.

● **Setpoint-, Alarm- and PID-related Parameters (Secondary)**

Located in: Main menu = **LP2** ; Submenu = **1.PID**

The table below lists the Target Setpoint-1 (1.SP) operating parameter and parameters that apply to the 1.SP parameter.

Parameter Symbol	Name of Parameter	Setting Range and Description	Initial Value	User Setting
1.SP	Target setpoint-1	0.0 to 100.0% of secondary PV input range However, between target setpoint limiter lower limit (SPL) and upper limit (SPH)	0.0% of secondary PV input range	
1.A1	Alarm-1 setpoint	PV alarm / SP alarm: -100.0 to 100.0% of secondary PV input range Deviation alarm: -100.0 to 100.0% of secondary PV input range span Output alarm: -5.0 to 105.0% Timer alarm (for alarm-1 only): 0.00 to 99.59 (hour, min.) or (min., sec.) Allows alarms 1 to 4 (1.A1 to 1.A4) to be set for target setpoint 1 (1.SP). Four alarms can also be set for target setpoints 2 to 8.	PV high limit/SP high limit alarm: 100.0% of secondary PV input range Deviation alarm: 0.0% of secondary PV input range span Other PV/SP low limit alarm: 0.0% of secondary PV input range Output high limit alarm: 100.0% Output low limit alarm: 0.0%	
1.A2	Alarm-2 setpoint			
1.A3	Alarm-3 setpoint			
1.A4	Alarm-4 setpoint			
1.P	Proportional band/Heating-side proportional band (in heating/cooling control)	0.1 to 999.9% In heating/cooling control: 0.0 to 999.9% (heating-side on/off control applies when 0.0)	5.0%	
1.I	Integral time Heating-side integral time (in heating/cooling control)	OFF (0), 1 to 6000 sec.	240 sec.	
1.D	Derivative time Heating-side derivative time (in heating/cooling control)	OFF (0), 1 to 6000 sec.	60 sec.	
1.OH	Output high limit Heating-side output high limit (in heating/cooling control)	-5.0 to 105.0% Heating-side limiter in heating/cooling control: 0.0 to 105.0% (1.OL < 1.OH)	100% Heating/cooling control: 100.0%	
1.OL	Output low limit Cooling-side output high limit (in heating/cooling control)	-5.0 to 105.0% Cooling-side limiter in heating/cooling control: 0.0 to 105.0% (1.OL < 1.OH) SD (shutdown): Set in manual operation in 4-20 mA control output. Output is 0 mA.	0.0% Heating/cooling control: 100.0%	
1.MR	Manual reset	-5.0 to 105.0% (enabled when integral time "1.I" is OFF) The manual reset value equals the output value when PV = SP is true. For example, if the manual reset value is 50%, the output value is 50% when PV = SP becomes true.	50.0%	
1.H	ON/OFF control hysteresis Heating-side ON/OFF control hysteresis (in heating/cooling control)	In ON/OFF control: 0.0 to 100.0% of secondary PV input range span In heating/cooling control: 0.0 to 100.0% Hysteresis can be set in the target setpoint when the controller is performing ON/OFF control.	ON/OFF control: 0.5% of secondary PV input range span Heating/cooling control: 0.5%	
1.DR	Direct/reverse action switching	REVERSE (0): reverse action, DIRECT (1): direct action 	REVERSE (0)	

Parameter Symbol	Name of Parameter	Setting Range and Description	Initial Value	User Setting
1.Pc	Cooling-side proportional band	0.0 to 999.9% of secondary PV input range (Cooling-side ON/OFF control applies when 0.0)	5.0%	
1.Ic	Cooling-side integral time	OFF (0), 1 to 6000 sec.	240 sec.	
1.Dc	Cooling-side derivative time	OFF (0), 1 to 6000 sec.	60 sec.	
1.Hc	Cooling-side ON/OFF control hysteresis	0.0 to 100.0%	0.5%	
1.DB	Dead band	In heating/cooling control: -100.0 to 50.0% • When performing heating/cooling control: setting any positive value prohibits both the heating and cooling outputs from turning on; setting any negative value allows both the heating and cooling outputs to turn on; and setting a value of zero either the heating or cooling output to turn on.	3.0%	
1.PO	Preset output/Heating-side preset output (in heating/cooling control)	-5.0 to 105.0% In heating/cooling control: Heating side 0.0 to 105.0% In Stop mode, fixed control output can be generated.	0.0%	
1.Oc	Cooling-side preset output	0.0 to 105.0% In Stop mode, cooling-side fixed control output can be generated.	0.0%	

If you are using two or more groups of setpoint, alarm and PID parameters, use the following table to record their values.

Parameter	n=2	n=3	n=4	n=5	n=6	n=7	n=8
n.SP							
n.A1							
n.A2							
n.A3							
n.A4							
n.P							
n.I							
n.D							
n.OH							
n.OL							
n.MR							
n.H							
n.DR							
n.Pc							
n.Ic							
n.Dc							
n.Hc							
n.DB							
n.PO							
n.Oc							

The following parameter is for cascade primary-loop.

● **Ten-segment Linearizer 1 Parameters (Primary)**

Located in: Main menu = **PYS1**

- Ten-segment linearizer biasing (factory-set default)

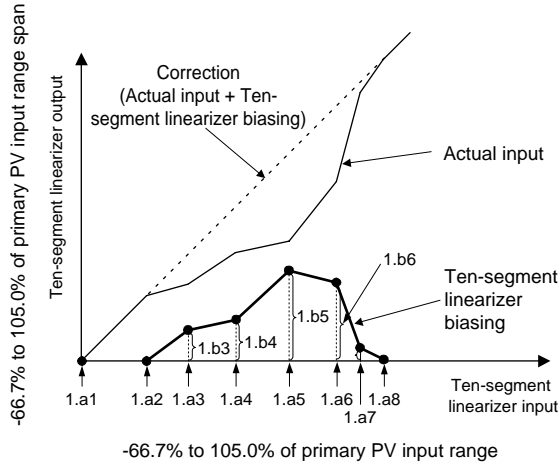

- Ten-segment linearizer approximation

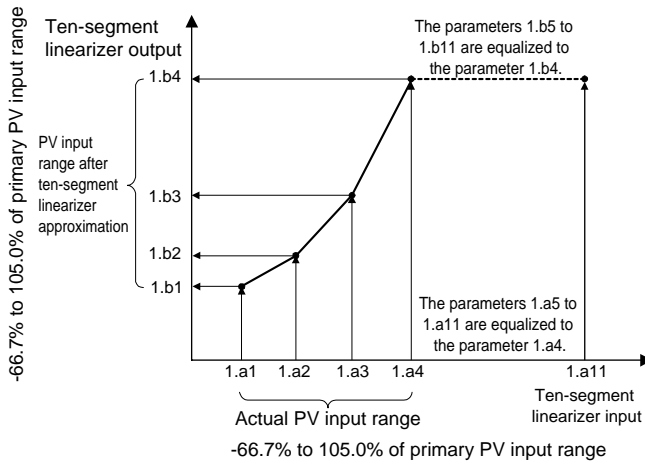

The following parameter is for cascade secondary-loop.

● **Ten-segment Linearizer 2 Parameters (Secondary)**

Located in: Main menu = PYS2

- Ten-segment linearizer biasing (factory-set default)

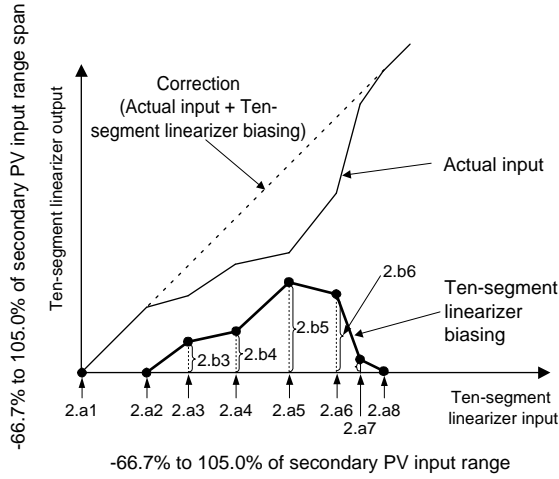

- Ten-segment linearizer approximation

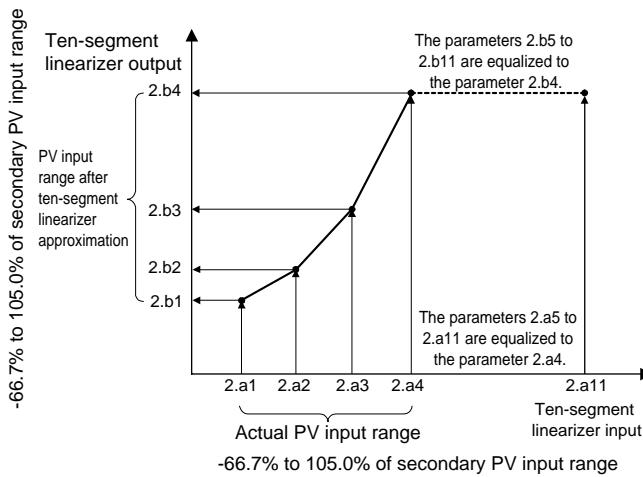

■ Setup Parameters

The following parameter is for cascade primary-loop.

● Target Setpoint-related Parameters (Primary)

Located in: Main menu = **LOOP1** ; Submenu = **SP**

Parameter Symbol	Name of Parameter	Setting Range and Description	Initial Value	User Setting
RMS	Remote input selection	RSP (0): Uses the value set remotely via remote input (terminals). COM (1): Uses the value set remotely via communication. (Common to the primary-loop and secondary-loop.)	RSP (0)	
SPT	SP tracking selection	OFF (0), ON (1) Tracking is performed when the mode changes from Remote to Local (The local setpoint keeps track of the remote setpoint.)	ON (1)	
PVT	PV tracking selection	Causes the setpoint to keep track of the PV value so the setpoint automatically reverts to its original value at a preset rate of change. The Setpoint Ramp-up (UPR) and Setpoint Ramp-down (DNR) parameters are used in combination. - Operating conditions - 1: Manual operation → Automatic operation; 2: Stop → Start of automatic operation; 3: Power-on; 4: Change SP number OFF (0): Disable ON (1): Enable	OFF (0)	
TMU	Ramp-rate time unit setting	Time unit of setpoint ramp-up (UPR) and setpoint ramp-down (DNR) HOUR (0): Denotes "per hour." MIN (1): Denotes "per minute."	HOUR (0)	
SPH	Target setpoint limiter upper limit	0.0% to 100.0% of primary PV input range. Note that SPL < SPH Places limits on the ranges within which the target setpoints (1.SP to 8.SP) are changed.	100.0% of primary PV input range	
SPL	Target setpoint limiter lower limit		0.0% of primary PV input range	

The following parameter is for cascade primary-loop.

● **Alarm-related Parameters (Primary)**

Located in: Main menu = **LOOP1** ; Submenu = **ALM**

Parameter Symbol	Name of Parameter	Setting Range and Description	Initial Value	User Setting	
AL1	Alarm-1 type	OFF (0), 1 to 31 (same as below) Common to all target setpoints.	1		
AL2	Alarm-2 type	OFF (0), 1 to 20, 25 to 31 1: PV high limit (energized, no stand-by action) 2: PV low limit (energized, no stand-by action)	2		
AL3	Alarm-3 type	3: Deviation high limit (energized, no stand-by action) 4: Deviation low limit (energized, no stand-by action)	1		
AL4	Alarm-4 type	5: Deviation high limit (de-energized, no stand-by action) 6: Deviation low limit (de-energized, no stand-by action) For other alarm types, see "2.7 Changing Alarm Type of Primary-loop." Common to all target setpoints.	2		
HY1	Alarm-1 hysteresis	0.0 to 100.0% of primary PV input range span Output alarm: 0.0 to 100.0% Allows margins to be set for an alarm setpoint. With the hysteresis settings, it is possible to prevent relays from chattering.	0.5% of primary PV input range span Output alarm: 0.5%		
HY2	Alarm-2 hysteresis	<p>Hysteresis for PV high limit alarm</p>			
HY3	Alarm-3 hysteresis				
HY4	Alarm-4 hysteresis				
DY1	Alarm-1 delay timer		0.00 to 99.59 (min., sec.) (enabled when alarm-1 type "AL1" is 1 to 20 or 28 to 31) An alarm is output when the delay timer expires after the alarm setpoint is reached.	0.00	
DY2	Alarm-2 delay timer	0.00 to 99.59 (min., sec.) (enabled when alarm-2 type "AL2" is 1 to 20 or 28 to 31)			
DY3	Alarm-3 delay timer	0.00 to 99.59 (min., sec.) (enabled when alarm-3 type "AL3" is 1 to 20 or 28 to 31)			
DY4	Alarm-4 delay timer	0.00 to 99.59 (min., sec.) (enabled when alarm-4 type "AL4" is 1 to 20 or 28 to 31)			
AMD	Alarm mode	Allows the alarm function to be enabled or disabled according to the operating condition. 0: Always active 1: Not active when in Stop mode 2: Not active when in Stop mode or manual operation	0		

The following parameter is for cascade primary-loop.

● **Control Action-related Parameters (Primary)**

Located in: Main menu = **LOOP1** ; Submenu = **CTL**

Parameter Symbol	Name of Parameter	Setting Range and Description	Initial Value	User Setting
OPR	Output velocity limiter	OFF (0) 0.1 to 100.0%/sec. can limit control output velocity	OFF (0)	
MOD	PID control mode	0: Standard PID control (with output bump at SP change) 1: Fixed Point control (without output bump at SP change) Choose "Fixed Point Control" when controlling pressure or flow rate.	0	
AR	Anti-reset windup (Excess integration prevention)	AUTO (0), 50.0 to 200.0% The larger Setting, the sooner PID computation (integral computation) stops. Used when the control output travels up to 100% or down to 0% and stays at this point.	AUTO (0)	
ZON	Zone PID selection	0: SP selection 1: Zone PID If set to "SP selection," allows PID constants to be selected for each target setpoint. If set to "Zone PID," automatically selects PID constants according to the temperature range set in the given Reference Point parameter. (Common to the primary-loop and secondary-loop.)	0	
R.MD	Restart mode	CONT (0): Continues action set before power failure. MAN (1): Starts from manual operation status AUTO (2): Continues action set before power failure in automatic operation. Allows you to determine how the controller should recover from a power failure of longer than 2 sec. (Common to the primary-loop and secondary-loop.)	CONT (0)	
R.TM	Restart timer	0 to 10 sec. Sets time between power on and the instant where controller starts computation. (Common to the primary-loop and secondary-loop.)	0 sec.	
GRP	PID group number	Allows you to determine how many groups of setpoint, alarm and PID parameters the controller should show. 1: Show one set. 2: Show two sets. 3: Show three sets. 4: Show four sets. 5 to 8: Show as many groups of parameters as have been set.	8	
1.RP	Zone PID reference point-1	0.0 to 100.0% of primary PV input range. Note that 1.RP ≤ 2.RP ≤ 3.RP ≤ 4.RP ≤ 5.RP ≤ 6.RP. Sets reference points at which switching is carried out between groups of PID constants according to the given temperature zone. You can set a maximum of six reference points and therefore a maximum of seven temperature zones. To enable this parameter, set the Zone PID Selection (ZON) parameter to "1". The example below sets reference points 1 and 2 to provide 3 zones to switch PID constants automatically. Maximum 7 zones selectable.	100.0% of primary PV input range	
2.RP	Zone PID reference point-2			
3.RP	Zone PID reference point-3			
4.RP	Zone PID reference point-4			
5.RP	Zone PID reference point-5			
6.RP	Zone PID reference point-6			

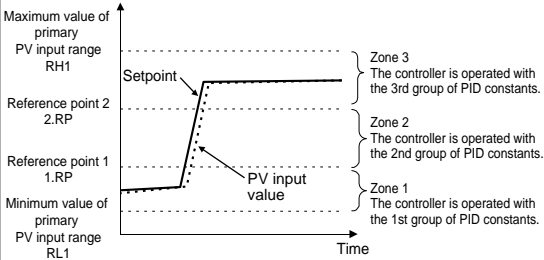

Parameter Symbol	Name of Parameter	Setting Range and Description	Initial Value	User Setting
RHY	Zone switching hysteresis	0.0 to 10.0% of primary PV input range span Allows hysteresis to be set for switching at a reference point.	0.5% of primary PV input range span	
RDV	Reference deviation	<p>Used to select a group of PID parameters according to a deviation from the given target setpoint. The controller uses the parameters of the number selected in PID group number (GRP) if the PV input falls outside the given deviation range.</p> <p>The following example shows a case when only the reference deviation is set without setting any reference point. The selected set of PID parameters is as follows.</p> <p>Since region 1 is within the deviation range, the controller uses the 1st group of PID parameters.</p> <p>Since region 2 is outside the deviation range, the controller uses the parameters of the number selected in PID group number (GRP).</p> <p>OFF (0): Disable 0.0% to 100.0% of primary PV input range span</p>	OFF (0)	

The following parameter is for cascade secondary-loop.

● **Target Setpoint-related Parameters (Secondary)**

Located in: Main menu = **LOOP2** ; Submenu = **SP**

Parameter Symbol	Name of Parameter	Setting Range and Description	Initial Value	User Setting
SPT	SP tracking selection	OFF (0), ON (1) Tracking is performed when the mode changes from Remote to Local (The local setpoint keeps track of the remote setpoint.)	ON (1)	
PVT	PV tracking selection	Causes the setpoint to keep track of the PV value so the setpoint automatically reverts to its original value at a preset rate of change. The Setpoint Ramp-up (UPR) and Setpoint Ramp-down (DNR) parameters are used in combination. - Operating conditions - 1: Manual operation → Automatic operation; 2: Stop → Start of automatic operation; 3: Power-on; 4: Change SP number OFF (0): Disable ON (1): Enable	OFF (0)	
TMU	Ramp-rate time unit setting	Time unit of setpoint ramp-up (UPR) and setpoint ramp-down (DNR) HOUR (0): Denotes "per hour." MIN (1): Denotes "per minute."	HOUR (0)	
SPH	Target setpoint limiter upper limit	0.0% to 100.0% of secondary PV input range. Note that SPL < SPH Places limits on the ranges within which the target setpoints (1.SP to 8.SP) are changed.	100.0% of secondary PV input range	
SPL	Target setpoint limiter lower limit		0.0% of secondary PV input range	

The following parameter is for cascade secondary-loop.

● **Alarm-related Parameters (Secondary)**

Located in: Main menu = **LOOP2** ; Submenu = **ALM**

Parameter Symbol	Name of Parameter	Setting Range and Description	Initial Value	User Setting
AL1	Alarm-1 type	OFF (0), 1 to 31 (same as below) Common to all target setpoints.	1	
AL2	Alarm-2 type	OFF (0), 1 to 20, 25 to 31 1: PV high limit (energized, no stand-by action) 2: PV low limit (energized, no stand-by action)	2	
AL3	Alarm-3 type	3: Deviation high limit (energized, no stand-by action) 4: Deviation low limit (energized, no stand-by action)	1	
AL4	Alarm-4 type	5: Deviation high limit (de-energized, no stand-by action) 6: Deviation low limit (de-energized, no stand-by action)	2	
HY1	Alarm-1 hysteresis	0.0 to 100.0% of secondary PV input range span Output alarm: 0.0 to 100.0%	0.5% of secondary PV input range span Output alarm: 0.5%	
HY2	Alarm-2 hysteresis	Allows margins to be set for an alarm setpoint. With the hysteresis settings, it is possible to prevent relays from chattering.		
HY3	Alarm-3 hysteresis	<p>Hysteresis for PV high limit alarm</p>		
HY4	Alarm-4 hysteresis			
DY1	Alarm-1 delay timer	0.00 to 99.59 (min., sec.) (enabled when alarm-1 type "AL1" is 1 to 20 or 28 to 31) An alarm is output when the delay timer expires after the alarm setpoint is reached.	0.00	
DY2	Alarm-2 delay timer	0.00 to 99.59 (min., sec.) (enabled when alarm-2 type "AL2" is 1 to 20 or 28 to 31)		
DY3	Alarm-3 delay timer	0.00 to 99.59 (min., sec.) (enabled when alarm-3 type "AL3" is 1 to 20 or 28 to 31)		
DY4	Alarm-4 delay timer	0.00 to 99.59 (min., sec.) (enabled when alarm-4 type "AL4" is 1 to 20 or 28 to 31)		
AMD	Alarm mode	Allows the alarm function to be enabled or disabled according to the operating condition. 0: Always active 1: Not active when in Stop mode 2: Not active when in Stop mode or manual operation	0	

The following parameter is for cascade secondary-loop.

● **Control Action-related Parameters (Secondary)**

Located in: Main menu = **LOOP2** ; Submenu = **CTL**

Parameter Symbol	Name of Parameter	Setting Range and Description	Initial Value	User Setting
OPR	Output velocity limiter	OFF (0) 0.1 to 100.0%/sec. can limit control output velocity	OFF (0)	
MOD	PID control mode	0: Standard PID control (with output bump at SP change) 1: Fixed Point control (without output bump at SP change) Choose "Fixed Point Control" when controlling pressure or flow rate.	0	
AR	Anti-reset windup (Excess integration prevention)	AUTO (0), 50.0 to 200.0% The larger Setting, the sooner PID computation (integral computation) stops. Used when the control output travels up to 100% or down to 0% and stays at this point.	AUTO (0)	
1.RP	Zone PID reference point-1	0.0 to 100.0% of secondary PV input range. Note that 1.RP ≤ 2.RP ≤ 3.RP ≤ 4.RP ≤ 5.RP ≤ 6.RP. Sets reference points at which switching is carried out between groups of PID constants according to the given temperature zone. You can set a maximum of six reference points and therefore a maximum of seven temperature zones. To enable this parameter, set the Zone PID Selection (ZON) parameter to "1". The example below sets reference points 1 and 2 to provide 3 zones to switch PID constants automatically. Maximum 7 zones selectable.	100.0% of secondary PV input range	
2.RP	Zone PID reference point-2			
3.RP	Zone PID reference point-3			
4.RP	Zone PID reference point-4			
5.RP	Zone PID reference point-5			
6.RP	Zone PID reference point-6			
RHY	Zone switching hysteresis	0.0 to 10.0% of secondary PV input range span Allows hysteresis to be set for switching at a reference point.	0.5% of secondary PV input range span	
RDV	Reference deviation	Used to select a group of PID parameters according to a deviation from the given target setpoint. The controller uses the parameters of the number selected in PID group number (GRP) if the PV input falls outside the given deviation range. The following example shows a case when only the reference deviation is set without setting any reference point. The selected set of PID parameters is as follows. Since region 1 is within the deviation range, the controller uses the 1st group of PID parameters. Since region 2 is outside the deviation range, the controller uses the parameters of the number selected in PID group number (GRP).	OFF (0)	
		OFF (0): Disable 0.0% to 100.0% of secondary PV input range span		

● Analog Input Computation Parameters

Located in: Main menu = **CMLP** ; Submenu = **AIN**

Parameter Symbol	Name of Parameter	Setting Range and Description	Initial Value	User Setting
A.BS1	Analog input-1 bias (primary)	Used to correct the primary PV input value beforehand. When in normal operation, use the PV Input Bias (BS) operation mode parameter. -100.0% to 100.0% of primary PV input range span	0.0% of primary PV input range span	
A.FL1	Analog input-1 filter (primary)	OFF (0): Disable 1 to 120 sec.	OFF (0)	
A.SR1	Analog input-1 square-root computation (primary)	Performs square-root computation for the primary PV input value. OFF (0): Do not compute the square root ON (1): Compute the square root	OFF (0)	
A.LC1	Analog input-1 low signal cutoff (primary)	0.0% to 5.0% The slope equals "1" at levels below the low-signal cutoff point.	1.0%	
A.BS2	Analog input-2 bias (secondary)	Used to correct the secondary PV input value. -100.0% to 100.0% of secondary PV input range span	0.0% of PV input range span	
A.FL2	Analog input-2 filter (secondary)	OFF (0): Disable 1 to 120 sec.	OFF (0)	
A.SR2	Analog input-2 square-root computation (secondary)	Performs square-root computation for the secondary PV input value. OFF (0): Do not compute the square root ON (1): Compute the square root	OFF (0)	
A.LC2	Analog input-2 low signal cutoff (secondary)	0.0% to 5.0% The slope equals "1" at levels below the low-signal cutoff point.	1.0%	
A.BS3	Analog input-3 bias	Used to correct the remote input value. -100.0% to 100.0% of secondary PV input range span	0.0% of secondary PV input range span	
A.FL3	Analog input-3 filter	OFF (0): Disable 1 to 120 sec.	OFF (0)	
A.SR3	Analog input-3 square-root computation	OFF (0): Do not compute the square root ON (1): Compute the square root	OFF (0)	
A.LC3	Analog input-3 low signal cutoff	0.0% to 5.0% The slope equals "1" at levels below the low-signal cutoff point.	1.0%	

● Retransmission Output Parameters

Located in: Main menu = **CMLP** ; Submenu = **RET**

Parameter Symbol	Name of Parameter	Setting Range and Description	Initial Value	User Setting
RET1	Retransmission output-1 type	OFF (0): Disable 1: PV1, 2: SP1, 3: OUT1, 4: LPS loop power supply (15 V), 5: PV2, 6: SP2, 7: OUT2 Retransmission output 1 is always provided via terminals 14 and 15. In heating/cooling control, an output value before allocation to heating/cooling control (0% to 100%) is transmitted if setpoint "7" is selected. (0% to 50%: Cooling-side output; 50% to 100%: Heating-side output)	1	
RTH1	Maximum value of retransmission output-1 scale	RET1=1, 2: RTL1 + 1 digit to 100.0% of PV input range RET1=3: RTL1 + 1 digit to 100.0%	100.0% of PV input range	
RTL1	Minimum value of retransmission output-1 scale	RET1=1, 2: 0.0% of PV input range to RTH1 - 1 digit RET1=3: 0.0% to RTH1 - 1 digit	0.0% of PV input range	
RET2	Retransmission output-2 type	Retransmission output-2 is available when the type of control output is not "current" or "voltage pulse." The output is provided via terminals 16 and 17. OFF (0): Disable 1: PV1, 2: SP1, 3: OUT1, 4: LPS loop power supply (15 V), 5: PV2, 6: SP2, 7: OUT2 In heating/cooling control, an output value before allocation to heating/cooling control (0% to 100%) is transmitted if setpoint "7" is selected. (0% to 50%: Cooling-side output; 50% to 100%: Heating-side output)	OFF (0)	
RTH2	Maximum value of retransmission output-2 scale	RET2=1, 2: RTL2 + 1 digit to 100.0% of PV input range RET2=3: RTL2 + 1 digit to 100.0%	100.0% of PV input range	
RTL2	Minimum value of retransmission output-2 scale	RET2=1, 2: 0.0% of PV input range to RTH2 - 1 digit RET2=3: 0.0% to RTH2 - 1 digit	0.0% of PV input range	

● Deviation Trend Parameters

Located in: Main menu = **CMLP** ; Submenu = **TRND**

Parameter Symbol	Name of Parameter	Setting Range and Description	Initial Value	User Setting
DVB1	Deviation display band (primary)	0.0 to 100.0% of primary PV input range span of the primary-loop Permits a change in the span of deviation shown on the front-panel deviation monitor.	1.0% of primary PV input range span	
DVB2	Deviation display band (secondary)	0.0 to 100.0% of secondary PV input range span of the secondary-loop Permits a change in the span of deviation shown on the front-panel deviation monitor.	1.0% of secondary PV input range span	
TSC1	Deviation trend scale (primary)	Allows the deviation axis on the Deviation Trend operating display to be re-scaled. 0.1 to 100.0% of primary PV input range span of the primary-loop	5.0% of primary PV input range span	
TSC2	Deviation trend scale (secondary)	Allows the deviation axis on the Deviation Trend operating display to be re-scaled. 0.1 to 100.0% of secondary PV input range span of the secondary-loop	5.0% of secondary PV input range span	
TTM	Deviation trend scan time	0 to 600 sec. Allows the time axis on the Deviation Trend operating display to be re-scaled.	5 sec.	

● **Security-related Parameters**

Located in: Main menu = **CMLP** ; Submenu = **LOCK**

Parameter Symbol	Name of Parameter	Setting Range and Description	Initial Value	User Setting
▼/▲	Front panel data setting (△,▽) key lock	OFF (0): Unlock ON (1): Lock	OFF (0)	
A/M	Front panel A/M key lock	OFF (0): Unlock ON (1): Lock	OFF (0)	
MODE	Operating parameter main menu [MODE] lock	OFF (0): Unlock ON (1): Lock	OFF (0)	
LP1	Operating parameter main menu [LP1] lock	OFF (0): Unlock ON (1): Lock	OFF (0)	
LP2	Operating parameter main menu [LP2] lock	OFF (0): Unlock ON (1): Lock	OFF (0)	
PID	Operating parameter main menu [PID] lock	OFF (0): Unlock ON (1): Lock	OFF (0)	
USR	Operating parameter main menu [USR] lock	OFF (0): Unlock ON (1): Lock	ON (1)	
PYS1	Operating parameter main menu [PYS1] lock	OFF (0): Unlock ON (1): Lock	OFF (0)	
PYS2	Operating parameter main menu [PYS2] lock	OFF (0): Unlock ON (1): Lock	OFF (0)	
PWD	Password setting	0: Password not set 1 to 30000	0	

● **SELECT Display Parameters**

Located in: Main menu = **CONF** ; Submenu = **CSEL**

Parameter Symbol	Name of Parameter	Setting Range and Description	Initial Value	User Setting
C.S1	SELECT display-1 registration	OFF (0), 201 to 1023 Select the desired parameter from among the operating and setup parameters, then register the number (D register No.) accompanying that parameter. For example, registering "302" for C.S1 allows you to change alarm-1 setpoint in operating display. Numbers for registering alarm SP parameter for operating display: Alarm-1 setpoint: 302 Alarm-2 setpoint: 303 Alarm-3 setpoint: 304 Alarm-4 setpoint: 305 Above numbers are alarm setpoint parameters for target setpoint-1 (1.SP). Set the registration number of the alarm setpoint parameter for target setpoint 2 (2.SP), to a value obtained by adding 25 to the registration number of the alarm setpoint parameter for the parameter 1.SP. Likewise, set the registration number of the alarm setpoint parameter for target setpoint 3 (3.SP), to a value obtained by adding 25 to the registration number of the alarm setpoint parameter for the parameter 2.SP. Likewise, the registration numbers for 4.SP to 8.SP can be obtained.	OFF (0)	
C.S2	SELECT display-2 registration			
C.S3	SELECT display-3 registration			
C.S4	SELECT display-4 registration			
C.S5	SELECT display-5 registration			

● **Contact Output Registration Parameters**

Located in: Main menu = **CONF** ; Submenu = **DO**

Parameter Symbol	Name of Parameter	Setting Range and Description	Initial Value	User Setting	
DO1	Relay output flag registration for DO1	The following setpoints are registration numbers for Cascade Control with Two Universal Inputs only. 5689: Alarm-1 output 0: No function 5690: Alarm-2 output 5691: Alarm-3 output 5693: Alarm-4 output	5689		
DO2	Relay output flag registration for DO2		5690		
DO3	Relay output flag registration for DO3		1607		
DO4	Open-collector transistor output flag registration for DO4		The following setpoints are only available for heating/cooling control. 1607: Cooling-side output 1609: Cooling-side output	1609	
DO5	Open-collector transistor output flag registration for DO5		5691		
DO6	Open-collector transistor output flag registration for DO6		Both the setpoints 1607 and 1609 provide the same cooling-side output value.	5693	
DO7	Open-collector transistor output flag registration for DO7		0		

Parameters R151 to R258 are shown only for a controller with communication function. See the CD-ROM edition of the user's manual for details on how to use these parameters.

● **Contact Input Registration Parameters**

Located in: Main menu = **CONF** ; Submenu = **DI**

Parameter Symbol	Name of Parameter	Setting Range and Description	Initial Value	User Setting	
A/M1	Loop-1 Auto/Manual switching	These parameters determine which contact input to use to make selections/switches listed on the left. DI1: 5161 No function: 0 DI2: 5162 DI3: 5163 DI4: 5164 DI5: 5165 DI6: 5166 DI7: 5167	0		
A/M2	Loop-2 Auto/Manual switching		0		
R/L1	Loop-1 Remote/Local switching		5165		
R/L2	Loop-2 Remote/Local switching		0		
S/R	Run/Stop switching		5164		
CAS	Switch to Cascade mode (when in cascade control)		The contact inputs are factory-set as shown below. Contact input 1 (DI1): Cascade switching (OFF → ON)	5161	
AUTO	Switch to Auto mode (when in cascade control)		Contact input 2 (DI2): Automatic switching (OFF → ON)	1411	
MAN	Switch to Manual mode (when in cascade control)	Contact input 3 (DI3): Manual switching (OFF → ON)	5163		
SP.0	Bit-0 of SP number setting	Contact input 4 (DI4): Stop (ON)/Run (OFF) switching	0		
SP.1	Bit-1 of SP number setting		0		
SP.2	Bit-2 of SP number setting		0		
SP.3	Bit-3 of SP number setting		0		
DP1	Operating display interruption-1		0		
DP2	Operating display interruption-2		0		
MG1	Message display interruption-1		5166		
MG2	Message display interruption-2		0		
MG3	Message display interruption-3		0		
MG4	Message display interruption-4		0		

● **UT Mode Parameters**

Located in: Main menu = **UTMD** ; Submenu = **MD**

Parameter Symbol	Name of Parameter	Setting Range and Description	Initial Value	User Setting
UTM	Controller mode (UT mode)	13: Cascade Control with Two Universal Inputs For another controller mode, see User's Manual (Reference) (CD-ROM version).	1	
SMP	PV sampling period setting	50, 100, 200 and 500 ms	200 ms	
SMEC	Sampling period error counter (reading only)	0 to 30000	Shows 0 at power-on.	

● **Input-related Parameters**

Located in: Main menu = **UTMD** ; Submenu = **IN**

Parameter Symbol	Name of Parameter	Setting Range and Description	Initial Value	User Setting
IN1	Primary PV input type (INPUT 1 terminals) Terminals ①, ② and ③	Specify the type of primary PV input as a range code. See "Instrument Input Range Codes" in the "2. Initial Settings."	OFF (0)	
UNI1	Primary PV input unit	Select the unit of primary PV input. % (0): Percent °F (5): Fahrenheit °C (1): Degree Celsius - (2): No unit	Depend on the primary PV input type	
RH1	Max. value of primary PV input range	Set the PV input range (RL1 < RH1). - For temperature input -	Depend on the primary PV input type	
RL1	Min. value of primary PV input range	Set the range of temperature that is actually controlled. - For voltage input - Set the range of a voltage signal that is applied. The scale across which the voltage signal is actually controlled should be set using the parameters Maximum Value of primary PV Input Scale (SH1) and Minimum Value of primary PV Input Scale (SL1).	Depend on the primary PV input type	
SDP1	Primary PV input decimal point position (shown when in voltage-input mode)	Set the position of the decimal point of voltage-mode primary PV input. 0 to 4 0: No decimal place 1: One decimal place 2 to 4: Two, three, four decimal places	Depend on the primary PV input type	
SH1	Max. value of primary PV input scale (shown when in voltage-input mode)	Set the read-out scale of voltage-mode primary PV input. -19999 to 30000, where SL1 < SH1, SH1 - SL1 <= 30000	Depend on the primary PV input type	
SL1	Min. value of primary PV input scale (shown when in voltage-input mode)		Depend on the primary PV input type	
BSL1	Selection of primary PV input burnout action	Allows the primary PV input value to be determined as shown below in case of primary PV input burnout. • 105% of primary PV input range if set to "Upscale" • -5.0% of primary PV input range if set to "Downscale" OFF (0): Disable UP (1): Upscale DOWN (2): Downscale	Depend on the primary PV input type	
RJC1	Presence/absence of primary PV input reference junction compensation	Allows input compensation to be applied to thermocouple input. OFF (0): Absent ON (1): Present	ON (1)	

Parameter Symbol	Name of Parameter	Setting Range and Description	Initial Value	User Setting
IN2	Secondary PV input type (INPUT 2 terminals) Terminals ④, ⑤ and ⑥	Specify the type of secondary PV input as a range code. See "Instrument Input Range Codes" in the "2. Initial Settings."	typeK1 (1)	
UNI2	Secondary PV input unit	Select the unit of secondary PV input. % (0): Percent °F (5): Fahrenheit °C (1): Degree Celsius - (2): No unit	°C (1)	
RH2	Max. value of secondary PV input range	Set the instrument input range (RL2 < RH2). - For temperature input -	1370.0	
RL2	Min. value of secondary PV input range	Set the range of temperature that is actually controlled. - For voltage input - Set the range of a voltage signal that is applied. The scale across which the voltage signal is actually controlled should be set using the parameters Maximum Value of secondary PV Input Scale (SH2) and Minimum Value of secondary PV Input Scale (SL2).	-270.0	
SDP2	Secondary PV input decimal point position (shown when in voltage-input mode)	Set the position of the decimal point of voltage-mode secondary PV input. 0 to 4 0: No decimal place 1: One decimal place 2 to 4: Two, three, four decimal places	2	
SH2	Max. value of secondary PV input scale (shown when in voltage-input mode)	Set the read-out scale of voltage-mode secondary PV input. -19999 to 30000, where SL2 < SH2, SH2 - SL2 ≤ 30000	100.00	
SL2	Min. value of secondary PV input scale (shown when in voltage-input mode)		0.00	
BSL2	Selection of secondary PV input burnout action	Allows the secondary PV input value to be determined as shown below in case of PV input burnout. • 105% of secondary PV input range if set to "Upscale" • -5.0% of secondary PV input range if set to "Downscale" OFF (0): Disable UP (1): Upscale DOWN (2): Downscale	OFF (0)	
RJC2	Presence/absence of secondary PV input reference junction compensation	Allows input compensation to be applied to thermocouple input. OFF (0): Absent ON (1): Present	ON (1)	
IN3	Remote input type (INPUT 3 terminals) Terminals ⑦ and ⑧	Specify the type of remote input as a range code. See "Instrument Input Range Codes" in the "2. Initial Settings."	1 to 5 V (41)	
UNI3	Remote input unit	Select the unit of remote input. % (0): Percent °F (5): Fahrenheit °C (1): Degree Celsius - (2): No unit	% (0)	
RH3	Maximum value of remote input range	Set the range of a voltage signal. (RL3 < RH3)	5.000	
RL3	Minimum value of remote input range		1.000	
SDP3	Remote input decimal point position	Set the position of the decimal point for remote input. 0 to 4	Same as the primary PV input decimal point position	
SH3	Max. value of remote input scale	Set the remote input read-out scale. -19999 to 30000, where SL3 < SH3, SH3 - SL3 ≤ 30000	Maximum value of primary PV input scale	
SL3	Min. value of remote input scale		Minimum value of primary PV input scale	
BSL3	Remote input burnout action selection	Allows the remote input value to be determined as shown below in case of remote input (standard signal) burnout. • 105% of remote input scale if set to "Upscale" • -5.0% of remote input scale if set to "Downscale" OFF (0): Disable UP (1): Upscal DOWN (2): Downscale	OFF (0)	

Parameter Symbol	Name of Parameter	Setting Range and Description	Initial Value	User Setting
P.UN1	PV1 unit (primary)	Set the unit of PV1. % (0): Percent °F (5): Fahrenheit °C (1): Degree Celsius - (2): No unit	Same as the primary PV input unit	
P.DP1	PV1 decimal point position (primary)	Under normal operation, set the same value as in the primary PV Input Decimal Point Position (SDP1) parameter. To shift the decimal point for temperature input, use this parameter. For example, set as "P.DP1 = 0" to change a temperature reading of one decimal place to that of no decimal places. This involves reconfiguring the P.RH1 and P.RL1 parameters. 0 to 4	-	
P.RH1	Maximum value of PV1 range (primary)	Under normal operation, keep the values of these parameters between the maximum and minimum values of the primary PV input range. -19999 to 30000 P.RL1 < P.RH1, where P.RH1-P.RL1 ≤ 30000	Maximum value of primary PV input range or scale	
P.RL1	Minimum value of PV1 range (primary)		Minimum value of primary PV input range or scale	
P.UN2	PV2 unit (secondary)	Set the unit of PV2. % (0): Percent °F (5): Fahrenheit °C (1): Degree Celsius - (2): No unit	Same as the secondary PV input unit	
P.DP2	PV2 decimal point position (secondary)	Under normal operation, set the same value as in the secondary PV Input Decimal Point Position (SDP2) parameter. To shift the decimal point for temperature input, use this parameter. For example, set as "P.DP2 = 0" to change a temperature reading of one decimal place to that of no decimal places. This involves reconfiguring the P.RH2 and P.RL2 parameters. 0 to 4	-	
P.RH2	Maximum value of PV2 range (secondary)	Under normal operation, keep the values of these parameters between the maximum and minimum values of the secondary PV input range. -19999 to 30000 P.RL2 < P.RH2, where P.RH2-P.RL2 ≤ 30000	Maximum value of secondary PV input range or scale	
P.RL2	Minimum value of PV2 range (secondary)		Minimum value of secondary PV input range or scale	

● Output-related Parameters

Located in: Main menu = **UTMD** ; Submenu = **OUT**

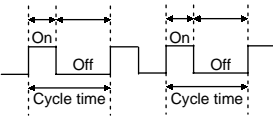
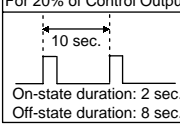
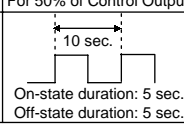
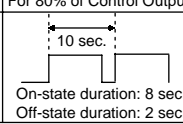
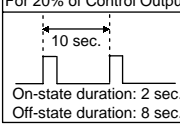
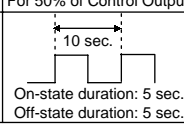
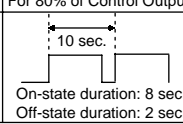
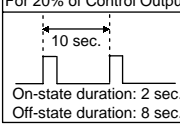
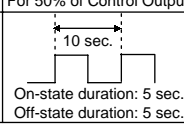
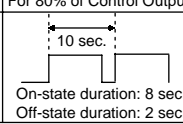
Parameter Symbol	Name of Parameter	Setting Range and Description	Initial Value	User Setting							
OT2	Control output type	0	Time proportional PID relay contact output (terminals ① - ② - ③)	0							
		1	Time proportional PID voltage pulse output (terminals ⑯ - ⑰)								
		2	Current output (terminals ⑯ - ⑰)								
		3	ON/OFF control relay contact output (terminals ① - ② - ③)								
		4	Heating-side relay output (terminals ① - ② - ③), cooling-side relay output (terminals ④ - ⑦)								
		5	Heating-side pulse output (terminals ⑯ - ⑰), cooling-side relay output (terminals ④ - ⑦)								
		6	Heating-side current output (terminals ⑯ - ⑰), cooling-side relay output (terminals ④ - ⑦)								
		7	Heating-side relay output (terminals ① - ② - ③), cooling-side transistor output (terminals ⑳ - ㉓)								
		8	Heating-side pulse output (terminals ⑯ - ⑰), cooling-side transistor output (terminals ⑳ - ㉓)								
		9	Heating-side current output (terminals ⑯ - ⑰), cooling-side transistor output (terminals ⑳ - ㉓)								
		10	Heating-side relay output (terminals ① - ② - ③), cooling-side current output (terminals ⑭ - ⑮)								
		11	Heating-side pulse output (terminals ⑯ - ⑰), cooling-side current output (terminals ⑭ - ⑮)								
		12	Heating-side current output (terminals ⑯ - ⑰), cooling-side current output (terminals ⑭ - ⑮)								
CT1	Control output cycle time Heating-side control output cycle time (in heating/cooling control)	1 to 1000 sec.	 <p>Relay's Behavior when Cycle Time = 10 sec.</p> <table border="1" data-bbox="657 1137 1228 1276"> <thead> <tr> <th>For 20% of Control Output</th> <th>For 50% of Control Output</th> <th>For 80% of Control Output</th> </tr> </thead> <tbody> <tr> <td>  </td> <td>  </td> <td>  </td> </tr> </tbody> </table>	For 20% of Control Output	For 50% of Control Output	For 80% of Control Output				30 sec.	
		For 20% of Control Output		For 50% of Control Output	For 80% of Control Output						
											
<p>CTc1</p>	<p>Cooling-side control output cycle time</p>	1 to 1000 sec.	30 sec.								
AO1	Analog output-1 type (OUTPUT 1: Terminals ⑯ and ⑰)	Allows control output or retransmission output to be presented as one of the following current signals. 0: 4 to 20 mA 1: 0 to 20 mA 2: 20 to 4 mA 3: 20 to 0 mA	0								
AO2	Analog output-2 type (OUTPUT 2: Terminals ⑯ and ⑰)		0								
AO3	Analog output-3 type (OUTPUT 3: Terminals ⑭ and ⑮)		0								
A1H	Analog output-1 100% segmental point	Set the values of segmental points for the 0% and 100% output levels at which the values are presented via OUTPUT-1 (terminals ⑯ and ⑰). See "■ Performing Split Computations" below. -5.0% to 105.0%	100.0%								
A1L	Analog output-1 0% segmental point		0.0%								
A2H	Analog output-2 100% segmental point	Set the values of segmental points for the 0% and 100% output levels at which the values are presented via OUTPUT-2 (terminals ⑯ and ⑰). See "■ Performing Split Computations" below. -5.0% to 105.0%	100.0%								
A2L	Analog output-2 0% segmental point		0.0%								
A3H	Analog output-3 100% segmental point	Set the values of segmental points for the 0% and 100% output levels at which the values are presented via OUTPUT-3 (terminals ⑭ and ⑮). See "■ Performing Split Computations" below. -5.0% to 105.0%	100.0%								
A3L	Analog output-3 0% segmental point		0.0%								

■ Performing Split Computations

[V-mode Output]

The following explains an example of letting “Analog OUTPUT-1 (terminals ⑬ and ⑭)” and “Analog OUTPUT-3 (terminals ⑮ and ⑯)” present the V-mode characteristics of split computations.

- [1] Set the Control Output Type (OT2) parameter to “2”.
This sets the control output to “current output.”
- [2] Set the Retransmission Output 1 (RET1) parameter to “7”.
This sets the retransmission output to “control output retransmission.”
- [3] Set the Analog Output-1 100% Segmental Point (A1H) parameter to “100%”.
- [4] Set the Analog Output-1 0% Segmental Point (A1L) parameter to “25%”.
- [5] Set the Analog Output-3 100% Segmental Point (A3H) parameter to “0%”.
- [6] Set the Analog Output-3 0% Segmental Point (A3L) parameter to “75%”.

The figure below shows an example where both analog outputs-1 and 3 are set to the current signal of 4 to 20 mA DC. The type of output signal can be determined separately for each of the analog outputs listed above, using the following three parameters.

- Analog output-1: Analog output-1 type (AO1)
- Analog output-2: Analog output-2 type (AO2)
- Analog output-3: Analog output-3 type (AO3)

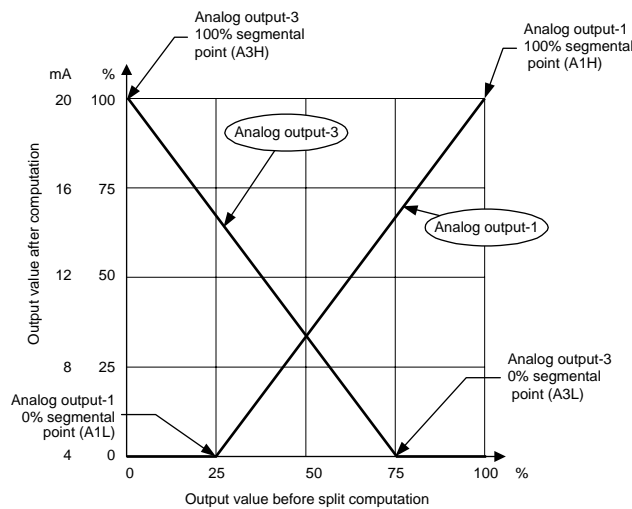

[Parallel-mode Output]

The following explains an example of letting “Analog OUTPUT-1 (terminals ⑩ and ⑪)” and “Analog OUTPUT-3 (terminals ⑭ and ⑮)” present the parallel-mode characteristics of split computations.

- [1] Set the Control Output Type (OT2) parameter to “2”.
This sets the control output to “current output.”
- [2] Set the Retransmission Output 1 (RET1) parameter to “7”.
This sets the retransmission output to “control output retransmission.”
- [3] Set the Analog Output-1 100% Segmental Point (A1H) parameter to “100%”.
- [4] Set the Analog Output-1 0% Segmental Point (A1L) parameter to “25%”.
- [5] Set the Analog Output-3 100% Segmental Point (A3H) parameter to “75%”.
- [6] Set the Analog Output-3 0% Segmental Point (A3L) parameter to “0%”.

The figure below shows an example where both analog outputs-1 and 3 are set to the current signal of 20 to 0 mA DC. The type of output signal can be determined separately for each of the analog outputs listed above, using the following three parameters.

- Analog output-1: Analog output-1 type (AO1)
- Analog output-2: Analog output-2 type (AO2)
- Analog output-3: Analog output-3 type (AO3)

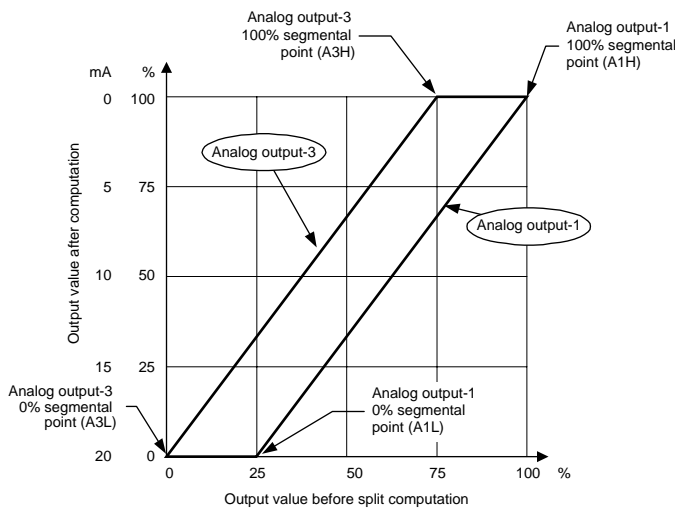

● Communication Parameters

Located in: Main menu = **UTMD** ; Submenu = **R485**

Parameter Symbol	Name of Parameter	Setting Range and Description	Initial Value	User Setting
PSL1	Protocol selection-1	0: PC link communication 1: PC link communication (with sum check) 2: Ladder communication 3: Coordinated master station 4: Coordinated slave station 7: MODBUS (ASCII) 8: MODBUS (RTU) 9: Coordinated master station (2 loop mode) 10: Coordinated slave station (loop-1 mode) 11: Coordinated slave station (loop-2 mode) (10, 11: When the master station is in dual-loop control, the slave station selects either of the loops to be controlled.) Terminal numbers: ②③, ②④, ②⑤, ②⑥ and ②⑦ (terminals for 4-wire connection)	0	
BPS1	Baud rate-1	600 (0), 1200 (1), 2400 (2), 4800 (3), 9600 (4) (bps)	9600 (4)	
PRI1	Parity-1	NONE (0): None EVEN (1): Even ODD (2): Odd	EVEN (1)	
STP1	Stop bit-1	1, 2	1	
DLN1	Data length-1	7, 8; 7 is fixed for MODBUS (ASCII) 8 is fixed for MODBUS (RTU), Ladder	8	
ADR1	Address-1	1 to 99 However, the maximum number of stations connectable is 31.	1	
RP.T1	Minimum response time-1	0 to 10 (× 10 ms)	0	
PSL2	Protocol selection-2	0: PC link communication 1: PC link communication (with sum check) 2: Ladder communication 3: Coordinated master station 4: Coordinated slave station 5: I/O expansion (for single-controller applications) 6: I/O expansion (for dual-controller applications) 9: Coordinated master station (2 loop mode) 10: Coordinated slave station (loop-1 mode) 11: Coordinated slave station (loop-2 mode) (10, 11: When the master station is in dual-loop control, the slave station selects either of the loops to be controlled.) Terminal numbers: ②⑧, ②⑨ and ②⑩ (terminals for 2-wire connection)	0	
BPS2	Baud rate-2	600 (0), 1200 (1), 2400 (2), 4800 (3), 9600 (4), 19200 (5), 38400 (6) (bps)	9600 (4)	
PRI2	Parity-2	NONE (0): None EVEN (1): Even ODD (2): Odd	EVEN (1)	
STP2	Stop bit-2	1, 2	1	
DLN2	Data length-2	7, 8 8 is fixed for Ladder	8	
ADR2	Address-2	1 to 99 However, the maximum number of stations connectable is 31.	1	
RP.T2	Minimum response time-2	0 to 10 (× 10 ms)	0	

● **Parameter-initializing Parameters**

Located in: Main menu = **UTMD** ; Submenu = **INIT**

Parameter Symbol	Name of Parameter	Setting Range and Description	Initial Value	User Setting
INI	Parameter initialization	Be sure to carry out parameter initialization when any change is made to the PV input type, PV input scale or decimal point position. OFF (0): - ON (1): Initialize parameters	OFF (0)	

■ Tips about Heating/Cooling Control

In heating/cooling control, the controller outputs the result of computation after splitting it into heating-purpose and cooling-purpose signals. In addition, the controller can perform PID control or ON/OFF control on the heating and cooling sides separately. When performing ON/OFF control, set the proportional band to "0".

The controller splits the result of computation (0 to 100%) into heating-side and cooling-side signals, as described below.

- 0% to 50% of the computation result is presented as a 0% to 100% cooling-side output.
- 50% to 100% of the computation result is presented as a 0% to 100% heating-side output.

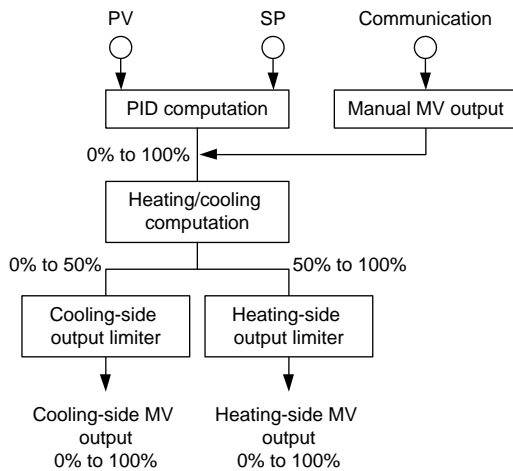

Heating/cooling control provides two methods in which either none of the heating- and cooling-side outputs are presented or both of the heating- and cooling-side outputs are presented, as shown in the following figures.

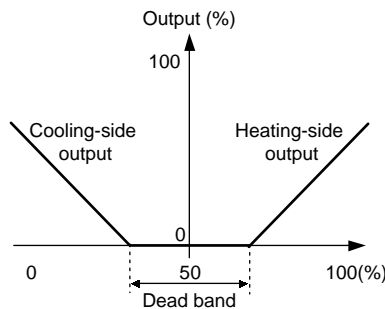

Value of control output before split into heating- and cooling-side outputs

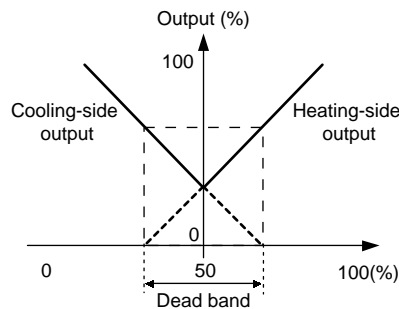

Value of control output before split into heating- and cooling-side outputs

Precautions in Heating/Cooling Control

- Keep the ratio of the heating-side proportional band (P) to the cooling-side proportional band (Pc) equal to or below 5.
- If neither the heating-side nor the cooling-side is performing ON/OFF control, setting the integral time (I or Ic) of one side to "0" results in the Integral Time parameters of both sides being set to "OFF", irrespective of the integral time setting of the other side.

6. Function Block Diagram and Descriptions

This chapter contains the function block diagrams for “Cascade control with two universal inputs,” and “Cascade heating/cooling control with two universal inputs.” For details on these function block diagrams, refer to the descriptions mentioned later.

Function Block Diagram for Cascade Control with Two Universal Inputs

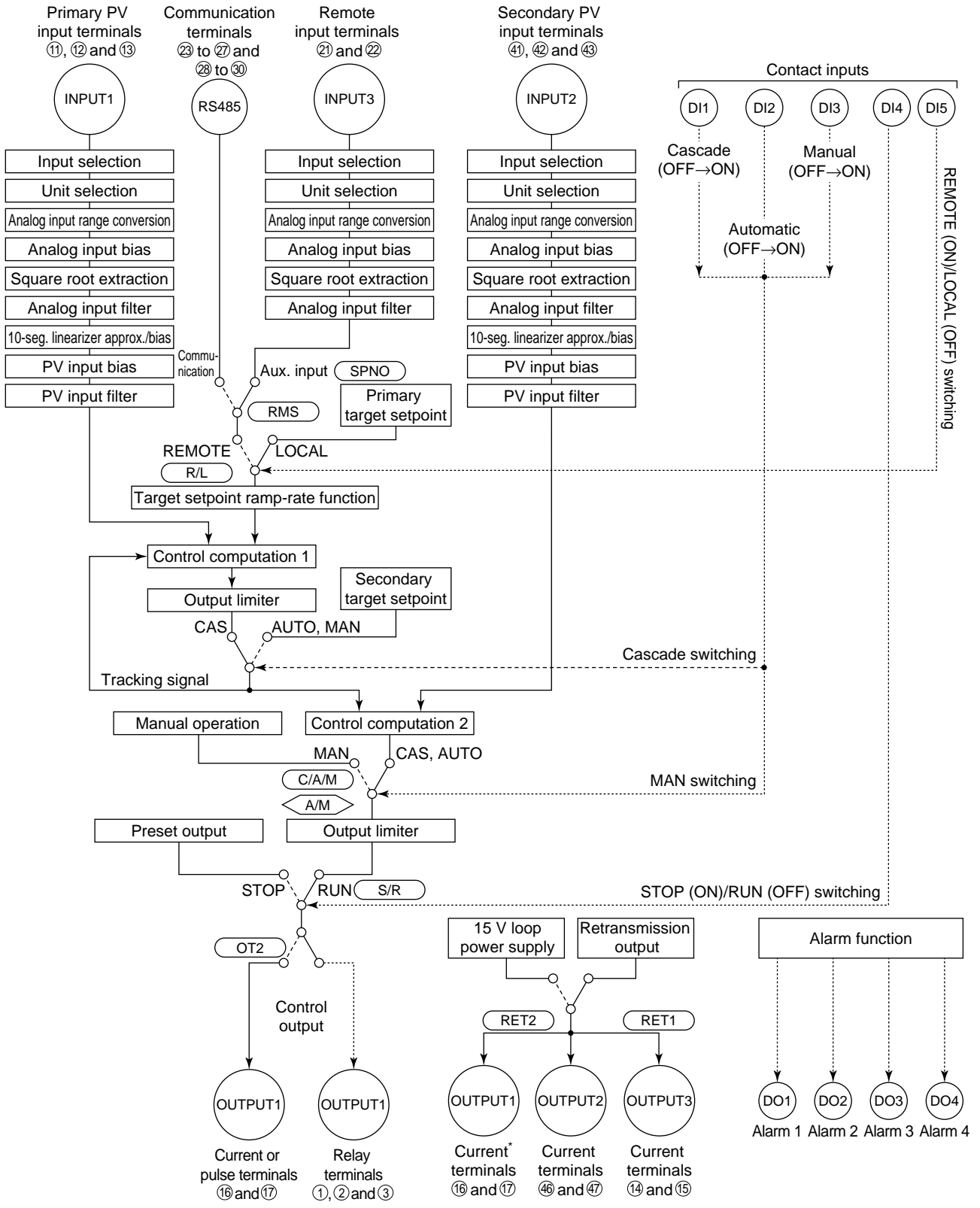

*: Unavailable when control output is current or pulse.

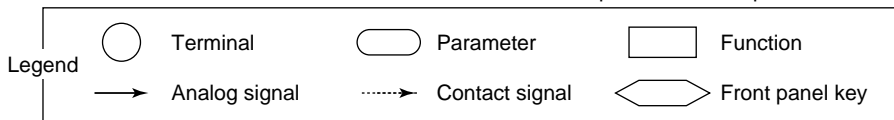

Function Block Diagram for Cascade Heating/Cooling Control with Two Universal Inputs

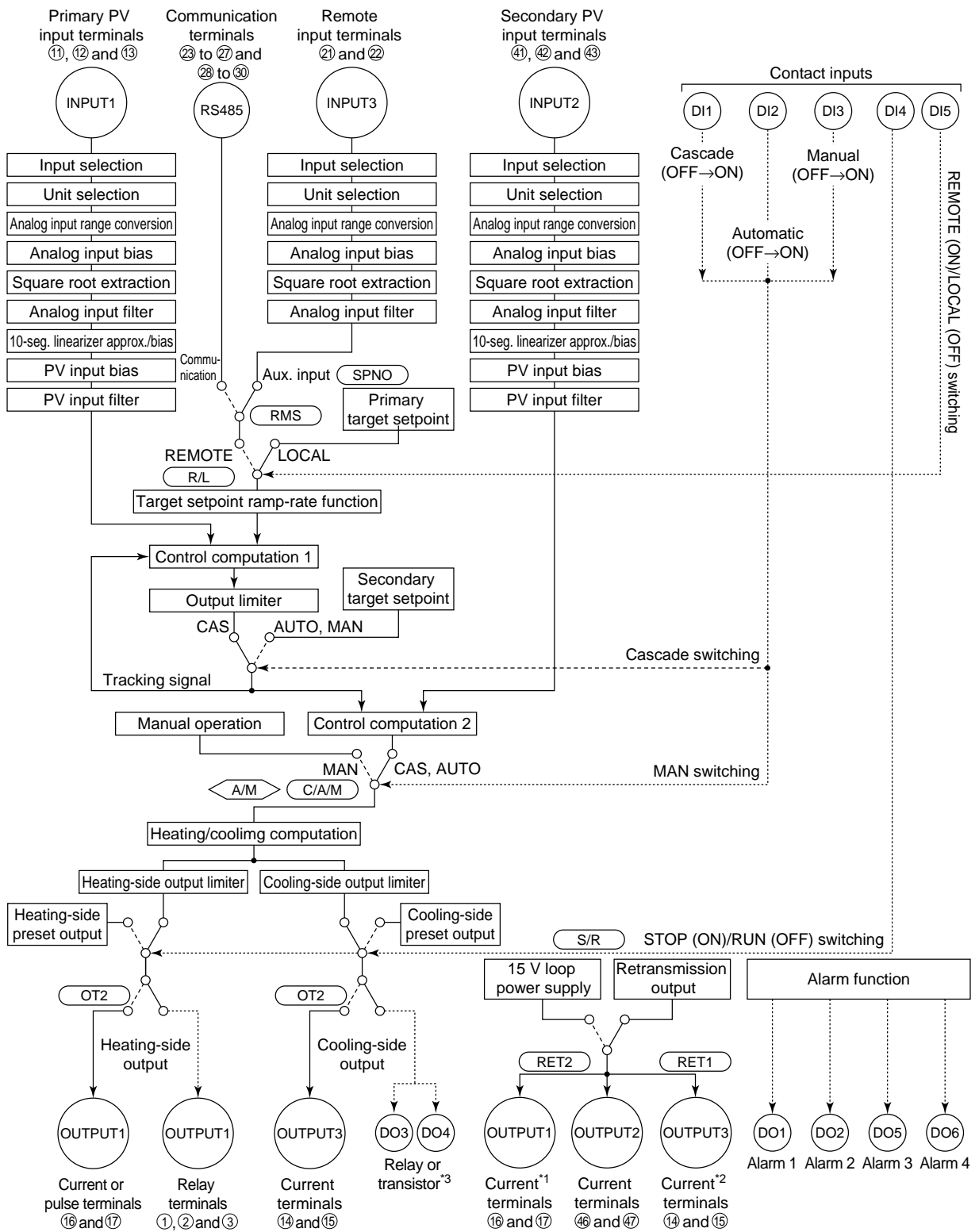

*1: Unavailable when heating-side output is current or pulse.
 *2: Unavailable when cooling-side output is current or pulse.
 *3: Alarm 4 is output via DO4 when cooling-side output is relay.
 Alarm 3 is output via DO3 when cooling-side output is transistor.

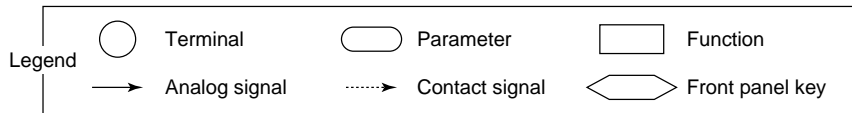

Functions and Parameters for “Cascade Control with Two Universal Inputs” in Initial State

Functions and parameters in initial state are given in the tables below. For details on each parameter, refer to “5.2 Lists of Parameters.”

■ PV Input of Primary-loop

PV input of the primary-loop (INPUT1) is a universal input, which can receive signals from thermocouple, RTD, or DC voltage signals. The controller is capable of biasing, square root extraction, first-order lag computation (filtering) ten-segment linearizer approximation, and ten-segment linearizer biasing on input signals.

Each function can be set by the following parameters.

Setup Parameters

Function	Parameter	Main menu	Submenu
Input selection	IN1	UTMD	IN
Unit selection	UNI1	UTMD	IN
Analog input range conversion	RH1, RL1 (SDP1, SH1, SL1)	UTMD	IN
Analog input bias	A.BS1	CMLP	AIN
Square root extraction	A.SR1, A.LC1	CMLP	AIN
Analog input filter	A.FL1	CMLP	AIN

Operating Parameters

Function	Parameter	Main menu	Submenu
Ten-segment linearizer mode	1.PMD	PYS1	None
Ten-segment linearizer approximation/biasing	1.a1 to 1.a11, 1.b1 to 1.b11	PYS1	None
PV input bias	BS	LP1	PAR
PV input filter	FL	LP1	PAR

Note: PV input bias (BS) and PV input filter (FL) among the operating parameters are used as bias and filter when normal operation. Analog input bias (A.BS1) and analog input filter (A.FL1) among the setup parameters are used when PV correction value is decided in advance.

■ PV Input of Secondary-loop

PV input of the secondary-loop (INPUT2) is a universal input, which can receive signals from thermocouple, RTD, or DC voltage signals. The controller is capable of biasing, square root extraction, first-order lag computation (filtering) ten-segment linearizer approximation, and ten-segment linearizer biasing on input signals.

Each function can be set by the following parameters.

Setup Parameters

Function	Parameter	Main menu	Submenu
Input selection	IN2	UTMD	IN
Unit selection	UNI2	UTMD	IN
Analog input range conversion	RH2, RL2 (SDP2, SH2, SL2)	UTMD	IN
Analog input bias	A.BS2	CMLP	AIN
Square root extraction	A.SR2, A.LC2	CMLP	AIN
Analog input filter	A.FL2	CMLP	AIN

Operating Parameters

Function	Parameter	Main menu	Submenu
Ten-segment linearizer mode	2.PMD	PYS2	None
Ten-segment linearizer approximation/biasing	2.a1 to 2.a11, 2.b1 to 2.b11	PYS2	None
PV input bias	BS	LP2	PAR
PV input filter	FL	LP2	PAR

Note: PV input bias (BS) and PV input filter (FL) among the operating parameters are used as bias and filter when normal operation. Analog input bias (A.BS2) and analog input filter (A.FL2) among the setup parameters are used when PV correction value is decided in advance.

■ Remote Input

Remote input (INPUT3) can receive DC voltage signals. The controller is capable of biasing, square root extraction, first-order lag computation (filtering), and ratio biasing on remote input signals.

Each function can be set by the following parameters.

Setup Parameters

Function	Parameter	Main menu	Submenu
Input selection	IN3	UTMD	IN
Unit selection	UNI3	UTMD	IN
Analog input range conversion	RH3, RL3 (SDP3, SH3, SL3)	UTMD	IN
Analog input bias	A.BS3	CMLP	AIN
Square root extraction	A.SR3, A.LC3	CMLP	AIN
Analog input filter	A.FL3	CMLP	AIN
Remote input selection	RMS	LOOP1	SP

Note: Remote input signal can be received via communication. For details, refer to "GREEN Series Communication Functions" (IM 05G01B02-01E).



Operating Parameters

Function	Parameter	Main menu	Submenu
Remote setting filter	RFL	LP1	PAR
Ratio bias calculation	RT, RBS	LP1	PAR
Remote/Local switching	MODE (REM/LOC1)	MODE	None

■ Contact Input

Cascade switching when DI1 (contact input 1) changes to on.

Automatic switching when DI2 (contact input 2) changes to on.

Manual switching when DI3 (contact input 3) changes to on. Manipulated output can be changed using the  and  keys in manual mode.

Run (OFF)/Stop (ON) switching function is assigned to DI4 (contact input 4). Preset output value is output when the operation is stopped. PV input and alarms remain functioning as normal.

Remote/Local mode switching function is assigned to DI5 (contact input 5). External target setpoint is received via remote input (INPUT3).

No function is assigned to DI6 (contact input 6) and DI7 (contact input 7).

■ Target Setpoint and PID (Primary-loop)

It is possible to use a maximum of eight groups of target setpoints and PID parameters in cascade mode. The target setpoint can be selected by key operation or contact input. For selection by contact input, refer to "Contact Input." The target setpoint number of primary-loop is same as that of secondary-loop.

Operating Parameters

Function	Parameter	Main menu	Submenu
Target setpoint number selection	SPNO	MODE	None
Target setpoints 1 to 8	n.SP	LP1	n.PID
Proportional band (P)	n.P	LP1	n.PID
Integral time (I)	n.I	LP1	n.PID
Derivative time (D)	n.D	LP1	n.PID

Note: Parameters n.SP, n.P, n.I, n.D, (n=1 to 8) and submenu n.PID (n=1 to 8) correspond to the target setpoint number selected in the target setpoint number selection (SPNO).

The target setpoint ramp rate setting function prevents the target setpoint from changing suddenly. It is possible to set the upward and downward changing rate (i.e., ramp rate) independently in the parameters UPR and DNR. The unit of the ramp rate (hour, or minute) is specified in TMU.

Setup Parameters

Function	Parameter	Main menu	Submenu
Ramp-rate time unit setting	TMU	LOOP1	SP

Operating Parameters

Function	Parameter	Main menu	Submenu
Target setpoint ramp-rate setting	UPR, DNR	LP1	PAR

■ Target Setpoint and PID (Secondary-loop)

It is possible to use a maximum of eight groups of target setpoint in automatic or manual mode (when the controller changes from the cascade mode). The target setpoint can be selected by key operation or contact input. For selection by contact input, refer to "Contact Input." The target setpoint number of primary-loop is same as that of secondary-loop.

Operating Parameters

Function	Parameter	Main menu	Submenu
Target setpoint number selection	SPNO	MODE	None
Target setpoints 1 to 8	n.SP	LP2	n.PID
Proportional band (P)	n.P	LP2	n.PID
Integral time (I)	n.I	LP2	n.PID
Derivative time (D)	n.D	LP2	n.PID
Cooling-side proportional band (Pc)	n.Pc	LP2	n.PID
Cooling-side integral time (Ic)	n.Ic	LP2	n.PID
Cooling-side derivative time (Dc)	n.Dc	LP2	n.PID

Note: Parameters n.SP, n.P, n.I, n.D, n.Pc, n.Ic, n.Dc (n=1 to 8) and submenu n.PID (n=1 to 8) correspond to the target setpoint number selected in the target setpoint number selection (SPNO).

The target setpoint ramp rate setting function prevents the target setpoint from changing suddenly. It is possible to set the upward and downward changing rate (i.e., ramp rate) independently in the parameters UPR and DNR. The unit of the ramp rate (hour, or minute) is specified in TMU.

Setup Parameters

Function	Parameter	Main menu	Submenu
Ramp-rate time unit setting	TMU	LOOP2	SP

Operating Parameters

Function	Parameter	Main menu	Submenu
Target setpoint ramp-rate setting	UPR, DNR	LP2	PAR

■ Control Output

Control output (OUTPUT1) selects the output type among the current output, voltage pulse output, and relay contact output signals.

Preset output value is output when the operation is stopped by contact input, which takes priority over the manual operation.

Each function can be set by the following parameters.

Setup Parameters

Function	Parameter	Main menu	Submenu
Control output type	OT2	UTMD	OUT
Control output cycle time	CT1	UTMD	OUT
Cooling-side control output cycle time	CTc1	UTMD	OUT
Analog output 1 type	AO1	UTMD	OUT

Operating Parameters

Function	Parameter	Main menu	Submenu
Preset output	n.PO	LP1	n.PID
Cooling-side preset output	n.POc	LP1	n.PID
Output limiter	n.OL, n.OH	LP1	n.PID

Note: Parameters n.PO, n.POc, n.OL, n.OH (n=1 to 8) and submenu n.PID (n=1 to 8) correspond to the target setpoint number selected in the target setpoint number selection (SPNO).

■ Contact Output

Alarm 1 is output via DO1 (contact output 1).

Alarm 2 is output via DO2 (contact output 2).

Alarm 3 is output via DO3 (contact output 3). When cooling-side output is set for relay output in heating/cooling control, cooling-side output is output via DO3. Alarm 3 is output via DO5.

Alarm 4 is output via DO4 (contact output 4). When cooling-side output is set for transistor output in heating/cooling control, cooling-side output is output via DO4. Alarm 4 is output via DO6.

Alarm 3 is output via DO5 (contact output 5).

Alarm 4 is output via DO6 (contact output 6).

No function is assigned to DO7 (contact output 7).

Setup Parameters

Function	Parameter	Main menu	Submenu
Alarm 1 type	AL1	LOOP1	ALM
Alarm 2 type	AL2	LOOP1	ALM
Alarm 3 type	AL3	LOOP1	ALM
Alarm 4 type	AL4	LOOP1	ALM

Operating Parameters

Function	Parameter	Main menu	Submenu
Alarm 1 setpoint	n.A1	LP1	n.PID
Alarm 2 setpoint	n.A2	LP1	n.PID
Alarm 3 setpoint	n.A3	LP1	n.PID
Alarm 4 setpoint	n.A4	LP1	n.PID

Note: Submenu n.PID (n=1 to 8) corresponds to the target setpoint number selected in target setpoint number selection (SPNO).

■ Retransmission Output

PV, target setpoint, or control output can be output to retransmission output 1 (OUTPUT3).

Retransmission output 2 (OUTPUT1) can be used when the control output is relay.

Each function can be set by the following parameters.

Setup Parameters

Function	Parameter	Main menu	Submenu
Retransmission output 1 type	RET1	CMLP	RET
Retransmission output 1 scale	RTH1, RTL1	CMLP	RET
Retransmission output 2 type	RET2	CMLP	RET
Retransmission output 2 scale	RTH2, RTL2	CMLP	RET

■ 15 V DC Loop Power Supply

The 15 V DC loop power supply (OUTPUT3) uses the same terminal as retransmission output 1 or 2. The 15 V DC loop power supply can not be used when retransmission output 1 or 2 is used. To use the 15 V DC loop power supply, set "4" in retransmission output 1 type (RET1) or retransmission output 2 type (RET2).

Each function can be set by the following parameters.

Setup Parameters

Function	Parameter	Main menu	Submenu
Retransmission output 1 type	RET1	CMLP	RET
Retransmission output 2 type	RET2	CMLP	RET

Revision Information

- Title : Model UT750 Digital Indicating Controller User's Manual for Cascade Control with Two Universal Inputs
- Manual No. : IM 05D01B02-53E

May 2000/1st Edition

Newly published

Jul 2004/2nd Edition

Change of the company name

Written by Yokogawa Electric Corporation

Published by Yokogawa Electric Corporation
2-9-32 Nakacho, Musashino-shi, Tokyo 180-8750, JAPAN

Blank Page

YOKOGAWA

Yokogawa Electric Corporation

YOKOGAWA ELECTRIC CORPORATION

Network Solutions Business Division

2-9-32, Nakacho, Musashino-shi, Tokyo, 180-8750 JAPAN

Phone: +81-422-52-7179 Facsimile: +81-422-52-6793

Sales Branch Offices

Tokyo, Nagoya, Osaka, Hiroshima, Fukuoka

YOKOGAWA CORPORATION OF AMERICA

Headquarters

2 Dart Road, Newnan, GA. 30265-1094 U.S.A.

Phone: +1-770-253-7000 Facsimile: +1-770-251-0928

Sales Branch Offices / Texas, Chicago, Detroit, San Jose

YOKOGAWA EUROPE B. V.

Headquarters

Databankweg 20, 3821 AL Amersfoort THE NETHERLANDS

Phone: +31-334-64-1611 Facsimile: +31-334-64-1610

Sales Branch Offices / Houten (The Netherlands), Wien (Austria), Zaventem (Belgium), Ratingen (Germany), Madrid (Spain), Bratislava (Slovakia), Runcorn (United Kingdom), Milano (Italy), Vélizy Villacoublay (France), Johannesburg (Republic of South Africa)

YOKOGAWA AMERICA DO SUL S.A.

Headquarters & Plant

Praca Acapulco, 31-Santo Amaro, Sao Paulo/SP, BRAZIL CEP-04675-190

Phone: +55-11-5681-2400 Facsimile: +55-11-5681-4434

YOKOGAWA ENGINEERING ASIA PTE. LTD.

Head office

5 Bedok South Road, Singapore 469270 SINGAPORE

Phone: +65-6241-9933 Facsimile: +65-6241-2606

YOKOGAWA ELECTRIC KOREA CO., LTD.

Seoul Sales office

395-70, Shindaebang-dong, Dongjak-gu, Seoul, 156-010, KOREA

Phone: +82-2-3284-3000 Facsimile: +82-2-3284-3019

YOKOGAWA TAIWAN CORPORATION

Head office

17F, No.39, Sec. 1, Chung Hwa Road Taipei, 100 TAIWAN

Phone: +886-2-2314-9166 Facsimile: +886-2-2314-9918

YOKOGAWA AUSTRALIA PTY. LTD.

Head office

Centre Court D1, 25-27 Paul Street North, North Ryde, N. S. W. 2113, AUSTRALIA

Phone: +61-2-9805-0699 Facsimile: +61-2-9888-1844

YOKOGAWA INDIA LTD.

Head office

40/4 Lavelle Road, Bangalore, 560 001, INDIA

Phone: +91-80-227-1513 Facsimile: +91-80-227-4270

LTD. YOKOGAWA ELECTRIC

Grokholskiy per. 13, Build. 2, 4th Floor, 129010, Moscow, RUSSIA FEDERATION

Phone: +7-095-737-7868 Facsimile: +7-095-737-7869
